



# *PowerBlox™*

Synchronous Step-Down Regulators  
Non Synchronous Step-Down Regulators



2009  
EXAR CORPORATION

Exar PowerBlox™ family of synchronous and non synchronous step-down regulators provides a fully integrated single chip solution for point-of-load applications with high current output requirements. The high input voltage range and operating switching frequency options allow the PowerBlox™ family to fit in a wide range of applications and power architectures by enabling step-down DC to DC conversions from various intermediate power bus levels while providing a highly efficient and performing solution in the most compact footprint.

### Exar's PowerBlox™ Family

Feature	Advantage	Benefit
High current density	Reduced solution footprint for high current load	Allows positioning of the power solution close to the load
High efficiency	Minimizes power overhead and power losses	Reduces heat dissipation requirements
Wide conversion range at high frequency	Single stage smallest solution possible at any input voltage	Reduces cost and complexity
Scalability	Common platform for wide range of applications	Short design time

#### Ultra Small Solution – Highest Current Density

Packing up to 12 Amps in 28mm<sup>2</sup>, Exar's unique package technology produces the industry's smallest 12A regulator.

The part is packaged in a custom DFN package with three integrated heat sinks for outstanding thermal management.

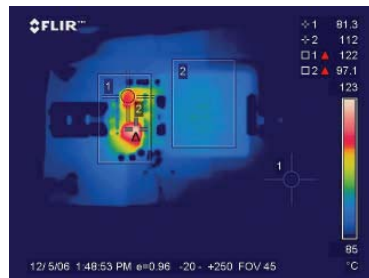

#### High Efficiency and Performance

With integrated high performance, low resistance FETs, the PowerBlox™ family achieves up to 95% efficiency.

Even at full load, the family is able to maintain an impressive level of efficiency, thus minimizing heat dissipation and energy usage.

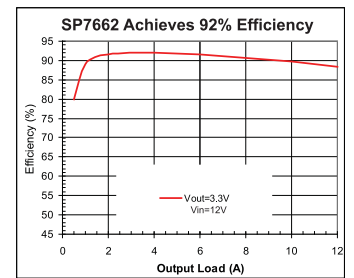

#### Ease of Use

PowerBlox™ enables and simplifies the creation of a power system or point of load. This device family is scalable to easily reuse the same design as the power and output current requirements increase. It is easily configurable for various power up sequencing requirements.

#### Low Duty Cycle - Wide Input Voltage Range

PowerBlox™ family supports input voltage from 2.5V up to 28V. A wide duty cycle range capability allows for output voltages from near the V<sub>in</sub> rail down to 0.8V. Exar's technology supports minimum on-time down to 40ns.

Part Number	Output Current	Frequency	Operating Voltage		Output Voltage	Output Voltage Range		Accuracy	Efficiency	Package	Features
			Min.	Max.		Min.	Max.				
SP7650	3A	300KHz	2.5V	28V	Adj.	0.8V	27V	1.0%	95%	26-pin DFN	Synchronous UVLO, OTP, Soft Start Short Circuit Protection /Auto Restart
SP7656	3A	600KHz	4.5V	29V	Adj.	0.6V	28V	1.0%	89%	8-pin SO8	Non synchronous UVLO, Current Limiting, Softstart Intenal Compensation
SP7661	3A	600KHz	3.0V	22V	Adj.	0.8V	20.2V	1.0%	92%	26-pin DFN	Synchronous UVLO, OTP, Soft Start, Current Limiting Short Circuit Protection /Auto Restart
SP7651	3A	900KHz	2.5V	20V	Adj.	0.8V	19V	1.0%	92%	26-pin DFN	Synchronous UVLO, OTP, Soft Start Short Circuit Protection /Auto Restart
SP7653	3A	1300KHz	2.5V	20V	Adj.	0.8V	19V	1.0%	91%	26-pin DFN	Synchronous UVLO, OTP, Soft Start Short Circuit Protection /Auto Restart
SP7652	6A	600KHz	2.5V	28V	Adj.	0.8V	27V	1.0%	92%	26-pin DFN	Synchronous UVLO, OTP, Soft Start Short Circuit Protection /Auto Restart
SP7663	6A	600KHz	3.0V	22V	Adj.	0.8V	20.2V	1.0%	91%	26-pin DFN	Synchronous UVLO, OTP, Soft Start, Current Limiting Short Circuit Protection /Auto Restart
SP7655	8A	300KHz	2.5V	28V	Adj.	0.8V	27V	1.0%	95%	26-pin DFN	Synchronous UVLO, OTP, Soft Start Short Circuit Protection /Auto Restart
SP7662	12A	300KHz	3.0V	22V	Adj.	0.8V	20.2V	1.0%	93%	26-pin DFN	Synchronous UVLO, OTP, Soft Start, Current Limiting Short Circuit Protection /Auto Restart

### Typical Application

12 Amperes – 3.3V output voltage using Exar's SP7662ER-L

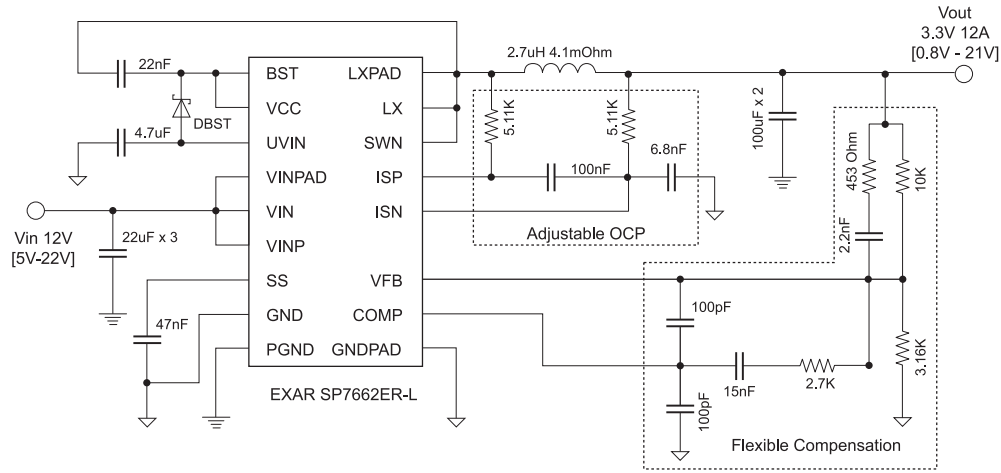

		Output Voltage (V)												
		0.9	1.0	1.1	1.5	1.8	2.5	2.8	3.3	5.0	9.6	12	18	
Input Voltage Rail (V)	2.5	SP7650 SP7651 SP7653 SP7652 SP7655	SP7650 SP7651 SP7653 SP7652 SP7655	SP7650 SP7651 SP7653 SP7652 SP7655	SP7650 SP7651 SP7653 SP7652 SP7655	SP7650 SP7651 SP7653 SP7652 SP7655	<b>PowerBlox</b> ™						<b>Power Lab</b> ™ power design made easy	
	2.8	SP7650 SP7651 SP7653 SP7652 SP7655	SP7650 SP7651 SP7653 SP7652 SP7655	SP7650 SP7651 SP7653 SP7652 SP7655	SP7650 SP7651 SP7653 SP7652 SP7655	SP7650 SP7651 SP7653 SP7652 SP7655								
	3.3	SP7650 SP7661 SP7651 SP7653 SP7652 SP7663 SP7655 SP7662	SP7650 SP7661 SP7651 SP7653 SP7652 SP7663 SP7655 SP7662	SP7650 SP7661 SP7651 SP7653 SP7652 SP7663 SP7655 SP7662	SP7650 SP7661 SP7651 SP7653 SP7652 SP7663 SP7655 SP7662	SP7650 SP7661 SP7651 SP7653 SP7652 SP7663 SP7655 SP7662	SP7650 SP7661 SP7651 SP7653 SP7652 SP7663 SP7655 SP7662	SP7650 SP7661 SP7651 SP7653 SP7652 SP7663 SP7655 SP7662	SP7650 SP7661 SP7651 SP7653 SP7652 SP7663 SP7655 SP7662	SP765x and SP766x requires 5V bias supply				
	5.0	SP7650 SP7656 SP7661 SP7651 SP7652 SP7663 SP7655 SP7662	SP7650 SP7656 SP7661 SP7651 SP7652 SP7663 SP7655 SP7662	SP7650 SP7656 SP7661 SP7651 SP7652 SP7663 SP7655 SP7662	SP7650 SP7656 SP7661 SP7651 SP7652 SP7663 SP7655 SP7662	SP7650 SP7656 SP7661 SP7651 SP7652 SP7663 SP7655 SP7662	SP7650 SP7656 SP7661 SP7651 SP7652 SP7663 SP7655 SP7662	SP7650 SP7656 SP7661 SP7651 SP7652 SP7663 SP7655 SP7662	SP7650 SP7656 SP7661 SP7651 SP7652 SP7663 SP7655 SP7662	SP7650 SP7656 SP7661 SP7651 SP7652 SP7663 SP7655 SP7662	SP765x requires 5V bias supply			
	9.6	SP7650 SP7656 SP7655 SP7662	SP7650 SP7656 SP7655 SP7662	SP7650 SP7656 SP7655 SP7662	SP7650 SP7656 SP7661 SP7652 SP7663 SP7655 SP7662	SP7650 SP7656 SP7661 SP7651 SP7652 SP7663 SP7655 SP7662	SP7650 SP7656 SP7661 SP7651 SP7652 SP7663 SP7655 SP7662	SP7650 SP7656 SP7661 SP7651 SP7652 SP7663 SP7655 SP7662	SP7650 SP7656 SP7661 SP7651 SP7652 SP7663 SP7655 SP7662	SP7650 SP7656 SP7661 SP7651 SP7652 SP7663 SP7655 SP7662	SP7650 SP7656 SP7661 SP7651 SP7652 SP7663 SP7655 SP7662	SP7650 SP7656 SP7661 SP7651 SP7652 SP7663 SP7655 SP7662	SP7650 SP7656 SP7661 SP7651 SP7652 SP7663 SP7655 SP7662	
	12	SP7650 SP7656 SP7655 SP7662	SP7650 SP7656 SP7655 SP7662	SP7650 SP7656 SP7655 SP7662	SP7650 SP7656 SP7661 SP7663 SP7655 SP7662	SP7650 SP7656 SP7661 SP7652 SP7663 SP7655 SP7662	SP7650 SP7656 SP7661 SP7651 SP7652 SP7663 SP7655 SP7662	SP7650 SP7656 SP7661 SP7651 SP7652 SP7663 SP7655 SP7662	SP7650 SP7656 SP7661 SP7651 SP7652 SP7663 SP7655 SP7662	SP7650 SP7656 SP7661 SP7651 SP7652 SP7663 SP7655 SP7662	SP7650 SP7656 SP7661 SP7651 SP7652 SP7663 SP7655 SP7662	SP7650 SP7656 SP7661 SP7651 SP7652 SP7663 SP7655 SP7662	SP7650 SP7656 SP7661 SP7651 SP7652 SP7663 SP7655 SP7662	
	18				SP7650 SP7656 SP7655 SP7662	SP7650 SP7656 SP7655 SP7662	SP7650 SP7656 SP7661 SP7652 SP7663 SP7655 SP7662	SP7650 SP7656 SP7661 SP7651 SP7652 SP7663 SP7655 SP7662	SP7650 SP7656 SP7661 SP7651 SP7652 SP7663 SP7655 SP7662	SP7650 SP7656 SP7661 SP7651 SP7652 SP7663 SP7655 SP7662	SP7650 SP7656 SP7661 SP7651 SP7652 SP7663 SP7655 SP7662	SP7650 SP7656 SP7661 SP7651 SP7652 SP7663 SP7655 SP7662	SP7650 SP7656 SP7661 SP7651 SP7652 SP7663 SP7655 SP7662	
	24					SP7656 SP7655	SP7656 SP7655	SP7656 SP7655	SP7656 SP7652 SP7655	SP7656 SP7652 SP7655	SP7656 SP7652 SP7655	SP7656 SP7652 SP7655	SP7656 SP7652 SP7655	SP7656 SP7652 SP7655

3A Solution

6A Solution

8A Solution

12A Solution

## PowerLab - Online Design Tool

Exar's PowerLab interactive online design tool helps create an optimized design solution complete with schematics, component values and simulation curves from a set of custom specifications. Click the PowerLab icon on the Exar website to start and finish your design today!





power design made easy

<http://www.exar.com/powerlab>

---

INPUT REQUIREMENTS
SOLUTION
DESIGN DETAILS
BILL OF MATERIALS
APPLICATION SUPPORT
ORDER SAMPLES

Please enter your power requirements and then click the "Solution" button. For access to advanced options, click the "SHOW" button.

INPUT		OUTPUT	
Input Voltage		Output Voltage/Current	
Vin Min	10.0 Volts	Number Of Outputs	1
Vin Max	14.0 Volts	Vout 1	3.3 Volts
Regulated 5V Bias	<input type="radio"/> Available <input checked="" type="radio"/> N/A	Iout Max 1	8.0 Amps

Optimization  Small Foot Print  High Efficiency

>100 LFM Airflow  Yes  No

Power Good  Yes  No

Integrated FETs?  Yes  No



When selecting a wide input voltage range below 5 V, please refer to user manual or contact Exar support for part selection.

INPUT REQUIREMENTS
SOLUTION
DESIGN DETAILS
BILL OF MATERIALS
APPLICATION SUPPORT
ORDER SAMPLES

**Design Rules**

Max Input Ripple Voltage (limit to): 100.0 mV

Capacitor Type  Ceramic  T

**OUTPUT 1**

Output Inductor 1  Let Power

Max Output Ripple Voltage 1 (limit to): 50.0

Transient Load Step 1: 50.0

Max. Tolerable Voltage Deviation 1 (during load step): 5.0

**Design Summary**

Root Vin Min	10.0 Volts	Root Reg Bias	N/A
Root Vin Max	14.0 Volts	Root Optimization	High Efficiency
Number of Inputs	1	Root Airflow	Available

**Output 1**

Vout 1	3.3 Volts	Iout Max	8.0 Amps
Max Output Ripple Voltage	50.0 millivolts	Transient Load Step	4 Amps
Max. Tolerable Voltage Deviation (during load step)	Volts		

**Outputs**

Output	Vout	Iout_max	IC	IC Options
Output 1	3.3	8.0	SP6133	...



### Evaluation Boards

Evaluation boards for all PowerBlox™ family of devices are available along with their user manual.



### Design Solutions

- DS05 SP7653 converts 5V input to 1.2V output at 2.5A
- DS06 SP7655 converts 24V input to 12V output at 8A
- DS33 Solution converts up to 28V input to drive LEDs to 6A
- DS39 Providing 48W (6A at 8V) from 12V input using PowerBlox™
- DS40 Converting 12V input to 1.2V output processor core voltage at up to 8A using PowerBlox™
- DS44 Converting up to 16V input to 2.5V output with PowerBlox™
- DS46 Improve efficiency and extend input voltage range of PowerBlox™ with application of external Vcc bias voltage
- DS47 High performance 3A output PowerBlox™ provides high performance over wide input voltage range
- DS52 Application of charge pump to utilize PowerBlox™ at only 3V input
- DS57 Using PowerBlox™ with up to 16V input for providing 3A LED drive current using only 0.5 inch<sup>2</sup>
- DS58 PowerBlox™ handles very low duty cycle: 22V input with 1.2V output to 8A
- DS61 SP7662 PowerBlox™ provides 12A LED drive current from a 15V nominal DC input
- DS63 SP7663 PowerBlox™ creates 5V at 4A supply off adapter 12V secondary
- DS65 SP7651 PowerBlox™ creates 2A peak current off adapter 12V secondary

### Application Notes

- ANP04 CAD layout recommendations for the PowerBlox™ family
- ANP05 Thermal resistance on SP765x devices
- ANP06 PowerBlox™ in distributed power architectures
- ANP15 Voltage mode control: the modulator in continuous current mode (CCM) of operations
- ANP25 PowerBlox™ thermal analysis
- ANP27 An alternative to POLA modules: PowerBlox™

Design Solutions and Application Notes are available for download at <http://www.exar.com/>

## Applications

- Distributed Power Architectures
- Point of Load Converters
- Point of Load Modules
- FPGA, DSPs and Processors Power Supplies

## Markets

- Telecom and Networking Equipment
- Set-Top Boxes
- Cable Modems
- Medical Equipment
- Video Processing and Interface Products

Actual Size

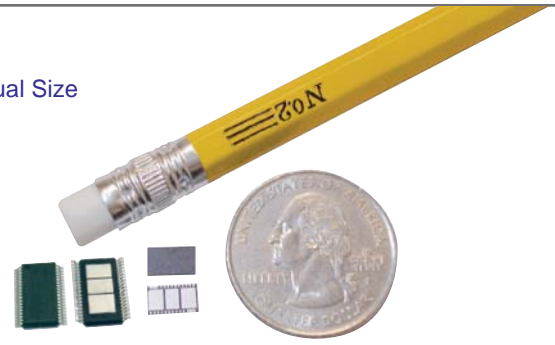

## PowerBlox™ Family Features

- 3A, 6A, 8A and 12A Synchronous Buck Regulators
- Integrated High and Low Side FETs
- 2.5V up to 28V Wide Input Voltage Conversions
- As Low as 0.8V Output Voltage
- 300Khz to 1.3MHz Operating Frequency
- Up to 95% Efficiency
- Type II & III Compensation
- Multiple Sequencing Options
- Short Circuit, Programmable UVLO and Thermal Protection
- PowerLab Online Design Creation Tool
- 7mm X 4mm DFN-26

## Feature Options

- Programmable Current Limiting
- Single Input Voltage Rail Operations

## Distributed Power Architecture

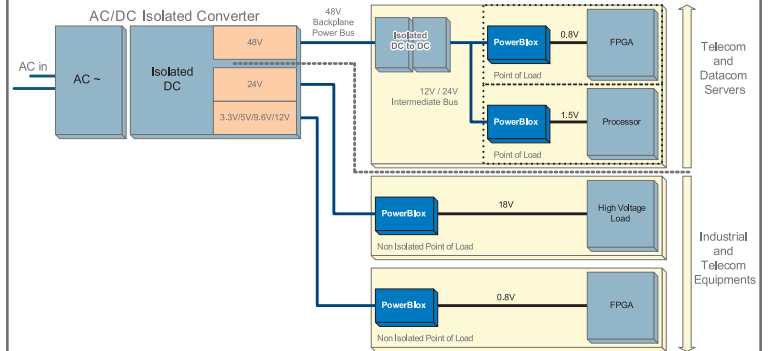

## Powering Up Sequence

Complex power-up sequencing and protocols eliminates the need for sequencing ICs and simplifies the system design while reducing the overall solution costs.

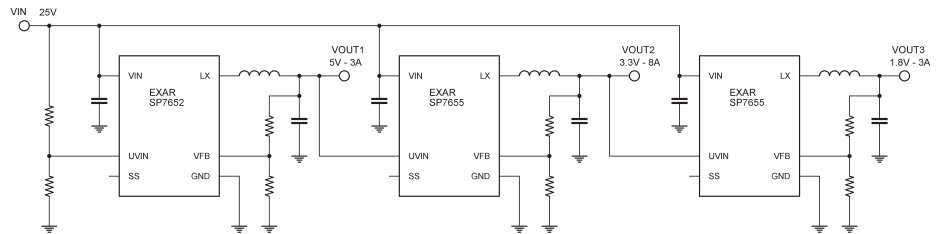
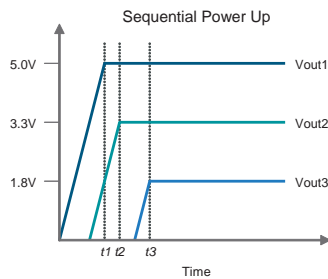

Vout1 powers up first then triggers Vout2 which powers up and triggers Vout3

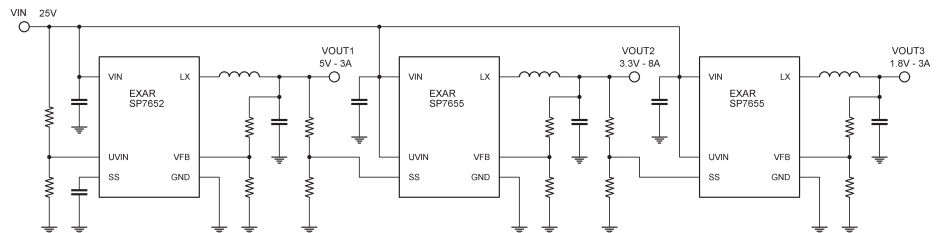
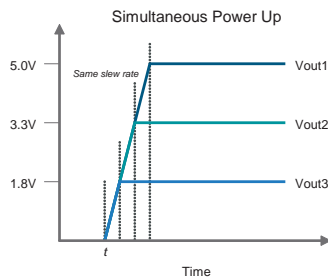

All converters begin their soft start cycle simultaneously with the same slew rate

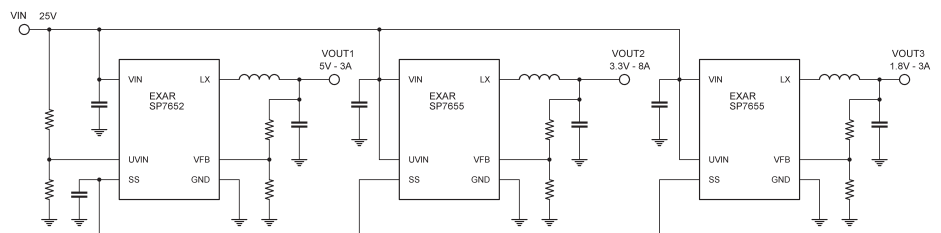
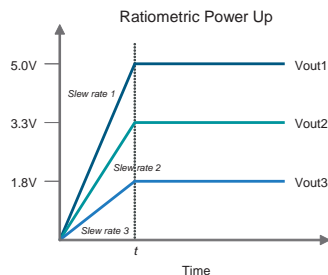

All supplies are turned on simultaneously and reach their respective output voltages at the same time



#### NORTH AMERICA

Exar Corporation, Fremont, CA, USA  
Exar Corporation, Palatine, IL, USA  
Exar Corporation, Billerica, MA, USA  
Exar Corporation, Raleigh, NC, USA  
Exar Corporation, Center Valley, PA, USA  
Exar Corporation, Dallas, TX, USA  
Exar Corporation, Atlanta, GA, USA  
Exar IC Canada Corporation, Montreal, Quebec, Canada

#### EUROPE

Exar SARL, Paris, France  
Exar GmbH, Munich, Germany  
Exar Ltd, London, United Kingdom  
Exar SRL, Milano, Italy

#### JAPAN

Exar Japan Corporation, Tokyo, Japan

#### ASIA PACIFIC

Exar Corporation Beijing Representative Office, Beijing, China  
Exar Corporation Shanghai Representative Office, Shanghai, China  
Exar Corporation Shenzhen Representative Office, Shenzhen, China  
Exar Korea Co. Ltd., Seoul, Korea  
Exar Pte Ltd., Singapore  
Exar Corporation Taiwan Branch Office, Taipei, Taiwan

[www.exar.com](http://www.exar.com)