

SELECTION GUIDE

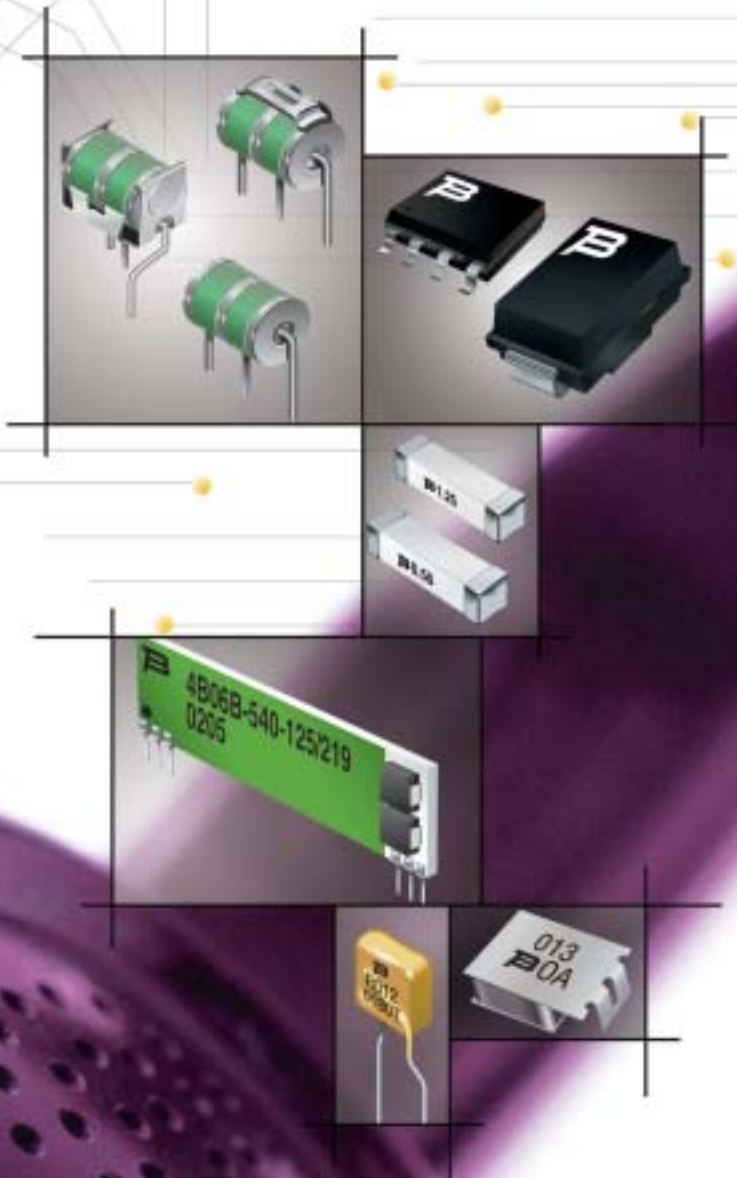

Telecom
Circuit Protection



Circuit Protection Solutions

The Bourns Mission

Our goal is to satisfy customers on a global basis while achieving sound growth with technological products of innovative design, superior quality and exceptional value. We commit ourselves to excellence, to the continuous improvement of our people, technologies, systems, products and services, to industry leadership and to the highest level of integrity.

Index

Introduction	2
Applications - What Protection do you Need?	
What is a Surge?	3
What is Protection?	3
Lightning - Global and Different	4
Where will the System be Used?	5
Coordination is No Longer Optional	6
Standards	6
System Technology	8
Location	8
Application - Central Office (CO) and Access	9
Application - Customer Premise Equipment (CPE)	12
Digital Technology	14
Useful Sources	15
Network Diagram	16 & 17
Technology - Which Protection Technology is Right for the Equipment?	
The Basics - Overvoltage and Overcurrent	18
What Happens After a Surge or if the Device Fails?	18
Speed and Accuracy are Major Factors in Determining Equipment Stress Levels	19
Technology Selection - Overvoltage Protectors	21
Gas Discharge Tubes (GDTs)	22
Thyristor-Based Devices	24
Metal Oxide Varistors (MOVs)	24
Transient Voltage Suppressors (TVSs)	25
Technology Selection - Overcurrent Protectors	25
Positive Temperature Coefficient (PTC) Thermistors	26
Fuses	27
Heat Coils	27
Line Feed Resistors	27
Thermal Switches	28
Modes of Overvoltage Protection	28
Technology Selection - Integrated Solutions	29
Multi-Stage Protectors	29
Integrated Line Protection Modules	30
Product Selection Guides	
Gas Discharge Tubes	32
Multifuse® PPTC Resettable Fuses	34
TISP® Thyristor Surge Protectors	35
Surge Line Protection Modules	41
Telefuse™ Telecom Fuses	43

Introduction

Bourns is pleased to present this comprehensive guide to Telecom Circuit Protection, encompassing our broad range of technologies and products. This guide will provide the background information and selection recommendations needed to ensure that your next project achieves the level of cost-effective field reliability demanded by today's customers.

Bourns commissioned a survey of Telecom Circuit Protection users worldwide to determine their priorities and needs. We found that reliability, technical and design support, and exemplary knowledge of protection technology were by far the three most cited items. Bourns is committed to meeting each of these three requirements:

Reliability – Reliability requires an understanding of the capabilities and specifications of circuit protection technology. Bourns has a global reputation for quality products, and our circuit protection devices have consistently demonstrated reliability in field applications. Bourns is committed to the complete support of a circuit protection solution for the life of a program.

Technical and Design Support – Bourns' team of specialized Sales and Field Application Engineers are ready to bring additional in-depth expertise to your next project. Through our interactive website and customer service locations, Bourns is always available to answer circuit protection design questions and provide valuable assistance and support.

Knowledge of Protection Technology – Bourns boasts the industry's widest range of Telecom over-voltage and overcurrent protectors. Our active involvement in international protection standards organizations ensures world-class technology and applications expertise.

Bourns continues to develop an innovative range of integrated circuit protection products using our knowledge and expertise to combine multiple technologies into optimized single devices designed to save both cost and board space. Whether you need a single product or a complete protection solution, Bourns Telecom Circuit Protection team is there to help you. We look forward to working with you.

Applications - What Protection is Needed?

Communication systems are vulnerable to electrical damage from lightning or other surges. As systems become more complex, they also become more vulnerable. Balancing the cost, standards compliance and field reliability of protection is both a commercial and technical challenge, compounded by the additional performance constraints of modern digital networks such as xDSL.

This section is intended to outline those challenges, illustrate the fundamentals of protection and identify those international standards relevant to specific applications. The next section will examine individual protection technologies and their selection.

Bourns engineers have helped designers with major projects in every region of the world, successfully protecting hundreds of millions of telephone circuits. Our uniquely broad range of protection solutions enables us to identify the most suitable technology for each application. Whether the goal is to achieve standards compliance or tackle a specific field problem, Bourns' experience and product offering are the solution to a myriad of design requirements.

Reliability Tip
Complying with standards does not guarantee field reliability.

What is a Surge?

A "surge" is a short-term increase in voltage or current. Both lightning and the AC power distribution system cause surges, but of very different magnitudes and durations (see Table 1). These events can either be via direct contact or by field or resistive coupling from events close to the telephone system, resulting in a wide variety of threats. For example, the effects of a power line fault caused by lightning may even be more threatening to the telephone system than the original lightning.

The dangers of large voltages and currents are obvious, but time is also important. Lightning is too fast for bulk heating to be critical, whereas for the longer term currents of AC power faults, heating effects

are significant for device survival and safety. Direct contact to the AC (power cross) causes high currents, while lower currents result from power induction. Obviously, a single device protection solution is seldom possible.

	Amplitude	Duration	Bulk Heating
Lightning	kA, kV	μs	Negligible
Power Cross	60 A	<30 mins	Significant
Power Induction	7 A	<30 mins	Crucial

Table 1. Different surge sources result in very different effects

Reliability Tip
Effective protection usually requires *overcurrent and overvoltage* devices.

What is Protection?

Protection performs several key functions as outlined in Figure 1: first it must prevent or minimize damage caused by a surge; then it must ensure that the system returns to a working condition with minimal disruption to service. It is vital that under normal conditions the protection does not interfere with the signal, creating special challenges for xDSL and other digital technologies. The protection must also fail in a safe manner during overstress.

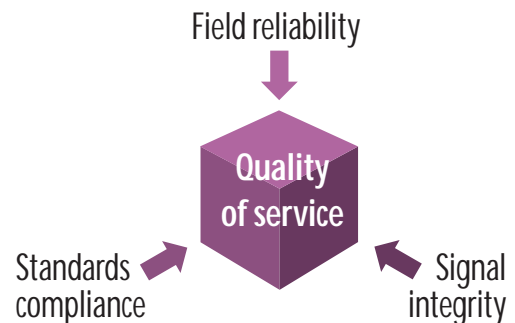

Figure 1. Protecting "Quality of Service" requires more than standards compliance

Within each of the core protection types listed in Table 2, there are several individual technologies. These will be reviewed in more detail in the Technology section. Each technology has different strengths and weaknesses, and only by understanding their relative merits can protection be optimized for a given installation. A quick review of Table 3 demonstrates that no single ideal solution exists for all locations within the telephone network so cascaded protection is often employed.

Protection Type	Action	Connection
Overcurrent	Limit peak current	Series (or parallel for primary)
Overvoltage	Limit peak voltage	Parallel
Overcurrent and Overvoltage	Coordinate voltage and current protection	Combination

Table 2. Protection falls into three basic types

Overvoltage

	Speed	Accuracy	Current Rating
GDT	Fair	Poor	Very high
Thyristor	Fair	Good	High
MOV	Fast	Poor	High
TVS	Very fast	Good	Very low

Overcurrent

	Speed	Accuracy	Current Rating
Polymer PTC Thermistor	Slow	Good	Low
Ceramic PTC Thermistor	Slow	Good	Low
Fuse	Very slow	Fair	Medium/High
Heat Coil	Very slow	Poor	Low
Thermal Switch	Very slow	Poor	High

Table 3. Summary of technology characteristics

Primary protection (Figure 2) diverts most of the surge energy away from the more sensitive/important areas of the system and is typically located at the

boundary of the premises. It is designed to redirect the bulk of the surge energy away from personnel and equipment by passing significant current to ground. Secondary protection (Figure 3) is optimized to protect the most sensitive parts of the equipment from any residual voltage surges let through by the Primary protector. Some telecommunications ICs have very precisely defined time-dependent Safe Operating Areas, requiring precise and predictable behavior as illustrated in Figure 4. There is typically some resistance added between the Primary and Secondary protection, either as part of the system requirements or the protection regime.

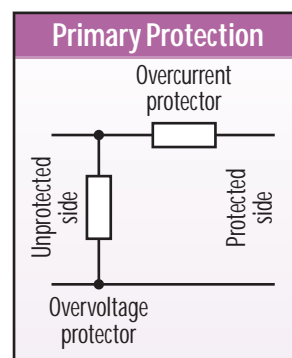

Figure 2. Typical format for Primary protection

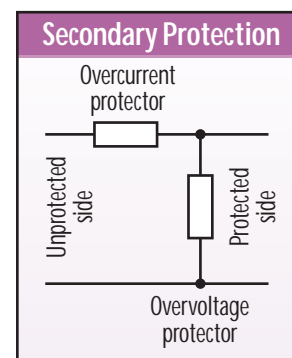

Figure 3. Typical format for Secondary protection

Lightning - Global and Different

Weather does not understand national boundaries, and varies with geography as shown in Figure 5. Partly for this reason, local standards have evolved to describe a lightning strike, usually containing major similarities, and critical differences. However, meeting each local standard is only the start of protection

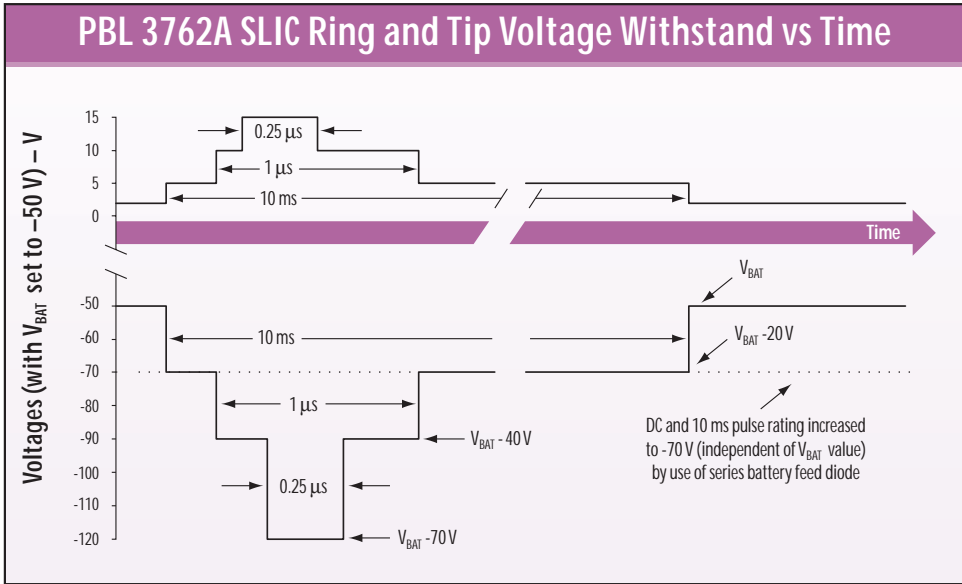

Figure 4. Telecom ICs have precisely defined Safe Operating Areas, requiring precise protection

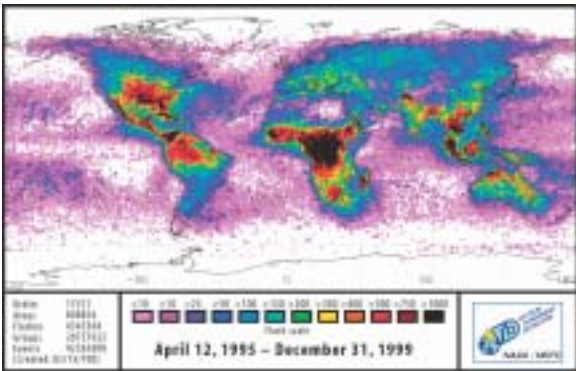

Figure 5. Lightning is global, but not uniform, as data from space emphasizes

Further Information
See thunder.nsstc.nasa.gov
for the latest published
lightning plot.

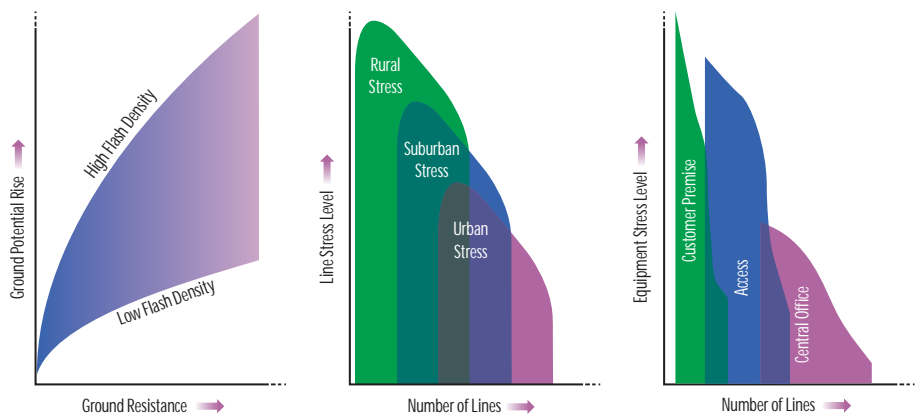

Figure 6. Location influences stress levels within telecommunications equipment

design. It requires a deeper understanding of protection to achieve the competitive advantage of reliable operation under field conditions.

Where will the System be Used?

Surge levels depend on both the original source energy and how it is distributed. Line density varies considerably in Central Office or Access Equipment within urban and rural areas. At higher

densities, individual line surges tend to be smaller as energy is spread over multiple pair counts. In loop applications pair counts tend to be lower, and in fiber rich environments, these loops are becoming shorter in length. Both trends tend to increase the surge energy distributed over individual lines.

For example, high exposure lines (remote terminals and less than 1,000 ft/300 m line length) with severe lightning surges are required under GR-974 and GR-1361 to have protection requirements of a current carrying capability of 2000 A 10/250. Within areas of similar flash density, factors such as ground resistivity (ρ), as well as the type of environment and equipment can have a direct impact on the resultant surge

amplitude, as illustrated in Figure 6. Therefore, depending on where it is deployed, each protection scheme will have different field reliability. For global deployment, once standards are met, engineers should understand potential field stress levels in order to predict levels of field reliability. For example, ITU-T K.44 Figure I.1-8/K.44 shows field AC induction surge levels measuring between 2 A, 3 s and 8 A, 0.2 s, implying that the sensitivity and dissipation of current protection can have a significant impact on maintenance issues.

Reliability Tip

Low flash density and high soil resistivity can produce more stress than high flash density and low resistivity.

Safety Tip

Equipment deployed in customer premises, and accessible to untrained personnel, has additional safety requirements.

Coordination is No Longer Optional

Consider the generic protection scheme of Figure 7. P1 is the primary protection, R is a coordination and current limit resistor and P2 is the secondary protection. Coordination will not occur if the secondary protection limiting voltage of R and P2 is lower than the sparkover voltage of P1 at the expected sparkover instant (see Figure 8). Both P1 and P2 may be

acceptable for individual purposes, but combined the interaction defeats the overall protection strategy. The potential for interaction is present wherever more than one protector is on the same line. The action of each device, whether within a single equipment or between equipments must be

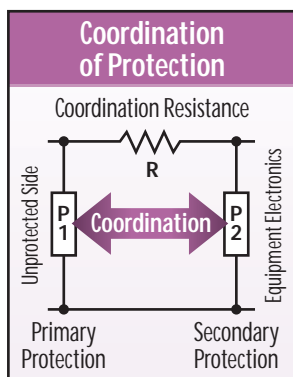

Figure 7. Coordination of protection is now mandatory for ITU-T compliance

coordinated. From the year 2000 forward, coordination of protection has been mandatory as part of ITU-T K.20, K.21, and K.45. Designing a coordinated protection scheme is no longer just good practice; it is a prerequisite to international compliance. Practical guidelines for protection coordination are presented in the Technology section.

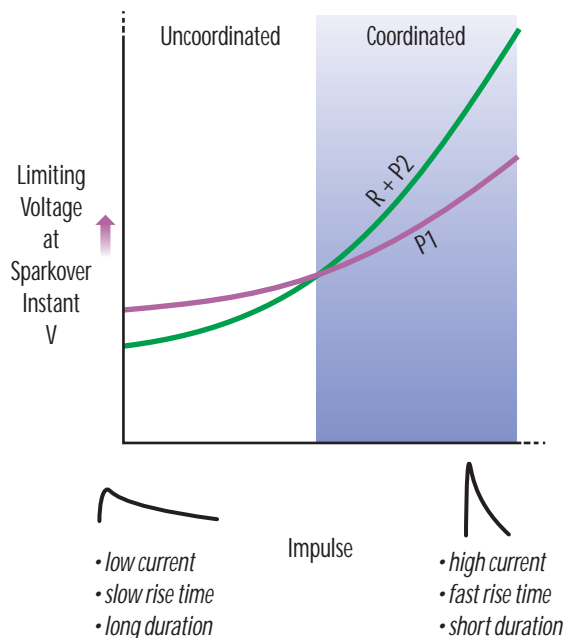

Figure 8. With different time-current characteristics, primary/secondary coordination is crucial

Standards Tip

Coordination of primary and secondary protection is now mandatory for ITU-T equipment compliance.

Standards

There are numerous regional and national standards, and even focusing on ITU-T and USA standards can be confusing. The Location section highlights where key standards are applicable within specific applications. As the standards change frequently, Bourns recommends obtaining the latest versions of the relevant documents. For example, the ITU-T recently introduced the concept of two-level “Basic” and “Enhanced” requirements within a single standard. For the future, work is underway at the World Trade

Standards Tip

In addition to international standards, it is always important to check the local requirements for target markets.

Further Information

Many standards include valuable application guidance.

Organization to consider unifying these multiple requirements into a single standard.

Since real world surges are unpredictable, even when standards are mandatory, compliance does not guarantee reliability. Satellite observation has enabled global counting of lightning flashes and work is underway to investigate the multiple strikes typically present in each flash. Since real world multiple surges are currently not modeled in the standards, they represent another area where field reliability is not assured. It is likely that standards will be extended to include such multiple surge tests.

Reliability Tip

Complying with standards does not guarantee field reliability.

Harsh operating conditions, high access or repair costs and demands for superior quality of service may all justify additional protection beyond the minimum levels within the standards. To illustrate the interaction of standards and protection design shown in Figure 9, TIA/EIA-IS-968 (FCC Part 68) specifies two levels of surge, Type A and Type B. Telecommunications equipment must survive and be operational after Type B surges, but is allowed to be non-operational after Type A surges.

This means that a system needing maintenance before returning to service, perhaps by replacing a fuse, could still be compliant. Upgraded protection, or careful coordination of protectors and current limiting devices could permit passing a Type A surge with an automatic return to service. This scenario may yield a higher component, but a lower lifetime cost.

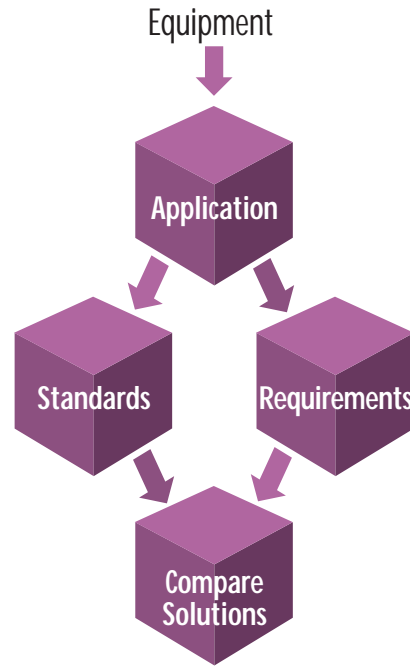

Figure 9. Compliance, technical and commercial requirements must influence protection design

	Bandwidth (bps)	System Voltage (Maximum)	Impedance (Ω)	Capacitance of Shunt Element	Protection Resistance
POTS	56 k	270 V	600	Non-critical	Non-critical
Pair Gain	160 k	145 V DC	150	Low	Low
ISDN	128/144 k	120 V DC	150	Low	Low
T1 / E1	1.5 - 2 M	150 V DC	120	Very low	Low
xDSL	2-50 M	Various	<100	Very low	Very low
HDSL	1.5M	190 V DC	<100	Very low	Very low

Table 4. System technology places different limitations on protection

Standards Tip

Some standards offer multiple levels of compliance. Designers must identify the right level for their target market.

Reliability Tip

Protection must be matched to the value and vulnerability of the equipment, as well as the down time and repair cost.

System Technology

The level of protection required and its justification depends on what is being protected. Table 4 and the following sections emphasize each system technology and the particular requirements and constraints placed on protection design.

The dynamics of a world market have a significant impact on protection design. For example, as Central Office copper lines transfer to access equipment, protection must be increasingly self-resetting and more effective at reducing expensive repair call-outs. Although line density is increasing in urban areas and reducing stress levels, installations are reaching more remote areas where surge threats increase substantially due to a lack of “shielding” from taller structures.

Digital services are also making new demands

on protection, both to permit increased bandwidth and to provide more precise protection of increasingly sophisticated and vulnerable line-card components. Recently, Telcordia issued a revision of GR-974 that addresses Next Generation Broadband Protectors. Bourns engineers worked with Telcordia on the development of this technology neutral specification.

Location

Protection requirements vary depending upon where the equipment is deployed (see Figure 10 and Tables 5 and 6). The Central Office (CO) or exchange and Customer Premises Equipment (CPE) are easily identified. Access is essentially everything else and typically covers intermediate network facilities such as those used to consolidate POTS lines onto fiber or coax. Although ITU-T applies different standards to each, from a protection point of view, CO and Access

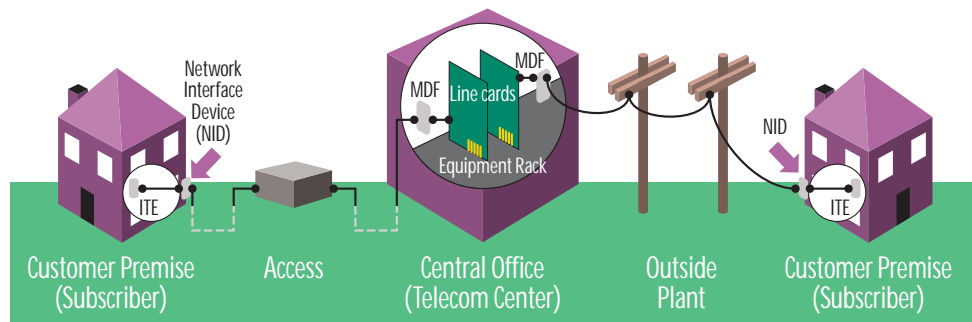

Access = Any equipment between the subscriber and the Telecom Center

Figure 10. Location determines which standards are applicable

International	Customer	Customer NID	Access	CO MDF	CO
Primary	K.28	X	X	X	
Secondary	K.20				X
	K.21	X			
	K.44	X	X		X
Safety	K.45		X		
	IEC 60950	X			

Notes:

K.44 describes the circuits to be used for testing.

K.36 provides useful guidelines for the selection of protective devices.

Table 5. Specific International standards for location within the system

are very similar. CPE standards, however, reflect the different technical and safety issues of an end user site.

Standards Tip
 Be sure to identify the right standards for your type of equipment, and for your planned regions of deployment.

Application - Central Office (CO) and Access

In addition to device technology, demand for increased density on line cards also requires attention to packaging. Surface mount packages and those containing multiple devices, including multi-chip modules with multiple technologies improve line density.

Connected directly to the telephone line, integrated circuits such as SLICs and LCASs are perhaps the

most vulnerable on the network. These are specialized components requiring precise protection normally provided by thyristor-based protectors. Working with several major suppliers of these circuits, Bourns developed a broad range of protectors designed to maximize protection for specific models of line card ICs, as illustrated in Figure 11.

USA	Customer	Customer NID	Access	CO MDF	CO
Primary	GR-974		X	X	
	GR-1361		X	X	
	RUS PE-80		X	X	
Secondary	TIA/EIA-IS-968 (FCC Part 68)	X			
	GR-1089	X	X		X
Safety	UL 60950	X			

Table 6. Specific USA standards for location within the system

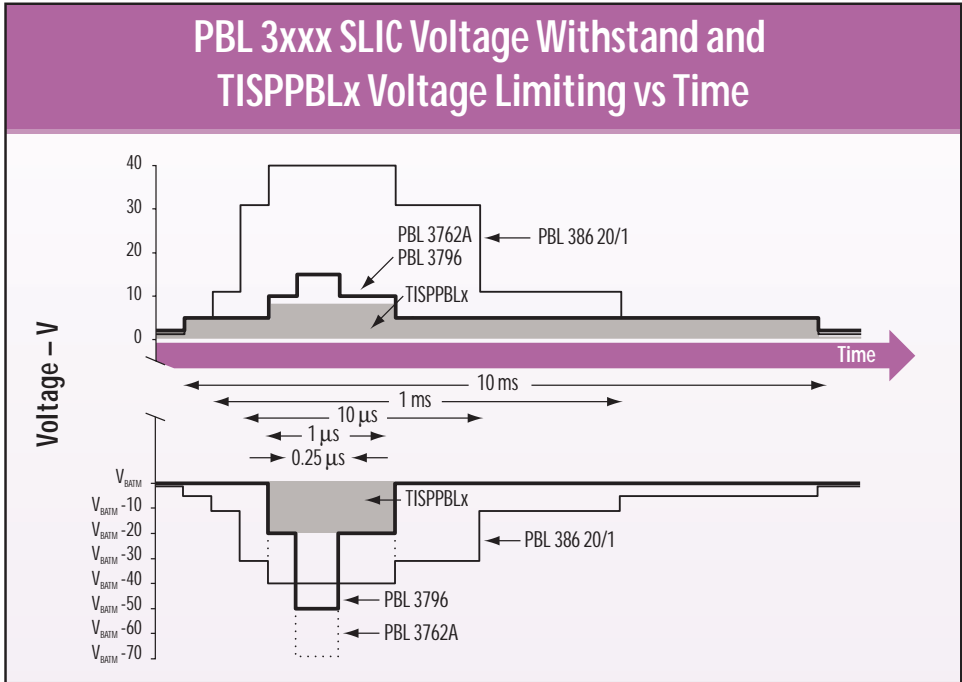

Figure 11. Thyristor protectors provide the precision to protect SLICs

Recent changes to ITU-T equipment standards made protection coordination mandatory. Documentation increased by over one hundred pages, emphasizing the need for timely review of new requirements. As well as monitoring changes, Bourns is an active contributor to the standards process.

Data Sheet Tip

Check for space-saving multiple device, or multiple technology components as well as surface mount packaging.

Standards Tip

Standards are updated, often with significant impact. Monitor current and future changes to confirm that your design remains compliant.

CO and Access - Key Relevant Standards

	International	USA
Primary protection	ITU-T K.28 (Thyristor) ITU-T K.12 (GDT) IEC 61643-311 (GDT)	GR-974 (Solid State & Hybrid) GR-1361 (GDT) RUS PE-80 (GDT)
Secondary protection	ITU-T K.20 (CO) ITU-T K.45 (Access) ITU-T K.44 IEC 61643-21	GR-1089
Component standards	ITU-T K.12 (GDT) IEC 61643-311 (GDT) IEC 61643-321 (TVS) IEC 61643-341 (Thyristor)	IEEE Std C62.31 (GDT) IEEE Std C62.32 (Carbon Block) IEEE Std C62.33 (MOV) IEEE Std C62.35 (TVS) IEEE Std C62.37 (Thyristor)
ESD protection	IEC 61000-4-2	IEC 61000-4-2

CO and Access - Recent / Future Standards

Organization	Standard	Comment
ITU-T	K.12, K.20, K.44 & K.45 K.44	New/revised in 2000 Revision anticipated
TELCORDIA	GR-974, GR-1089	Revised for 2002
EN/IEC	61643-311-321, 341, -21	New for 2001
EN/IEC	MOV, Modules	Anticipated 2002-2004
IEEE	C62.31 (GDT), C62.32 (Carbon Block), C62.37 (Thyristor)	In revision for 2003 Reaffirmed in 2002
ACTA	TIA/EIA-IS-968	New for 2001, Replaces FCC Part 68

CO and Access - Suitable Protection Technologies

	Primary	Secondary	
GDT	Y	H	Voltage Protection
Thyristor	Y	Y	
MOV	H		
TVS	H		Current Protection
PTC Thermistor	Y	Y	
Fuse		Y	
Thermal Switch	Y		
Heat Coil	A		
Line Protection Module		Y	

Y = Suitable

H = Suitable as part of GDT hybrid

A = Suitable except for ADSL and higher data rates

CO and Access - Relevant Sub-assemblies

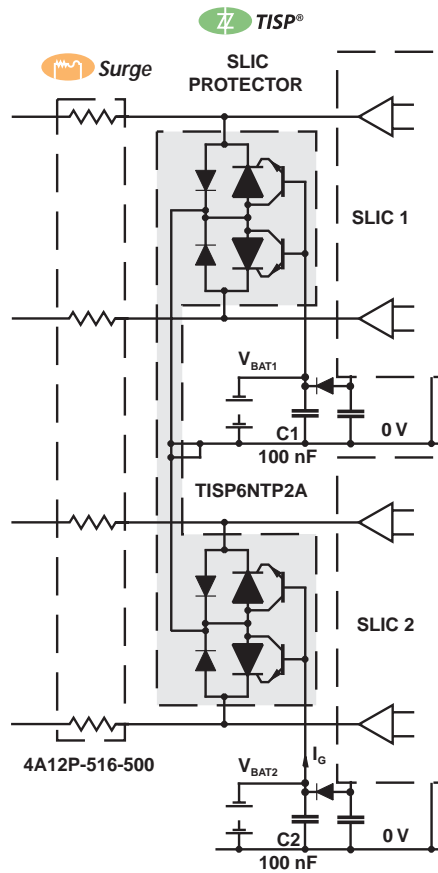

Integrated Line Protection for Multiple SLICs

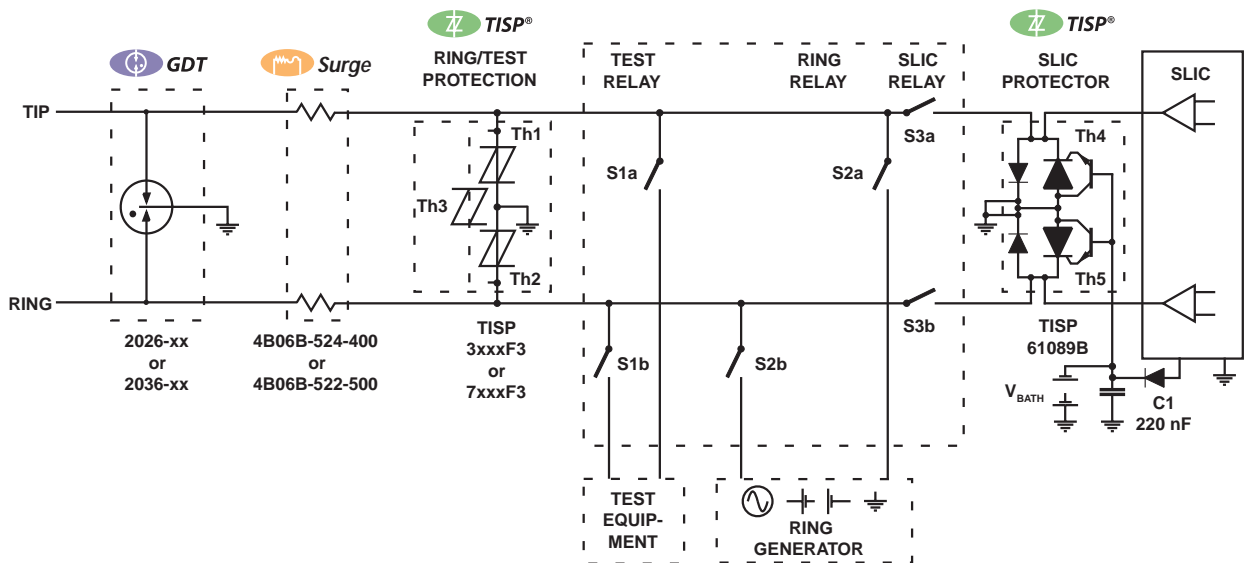

Linecard Protection with Electromechanical Relays

CO and Access - Relevant Sub-assemblies (continued)

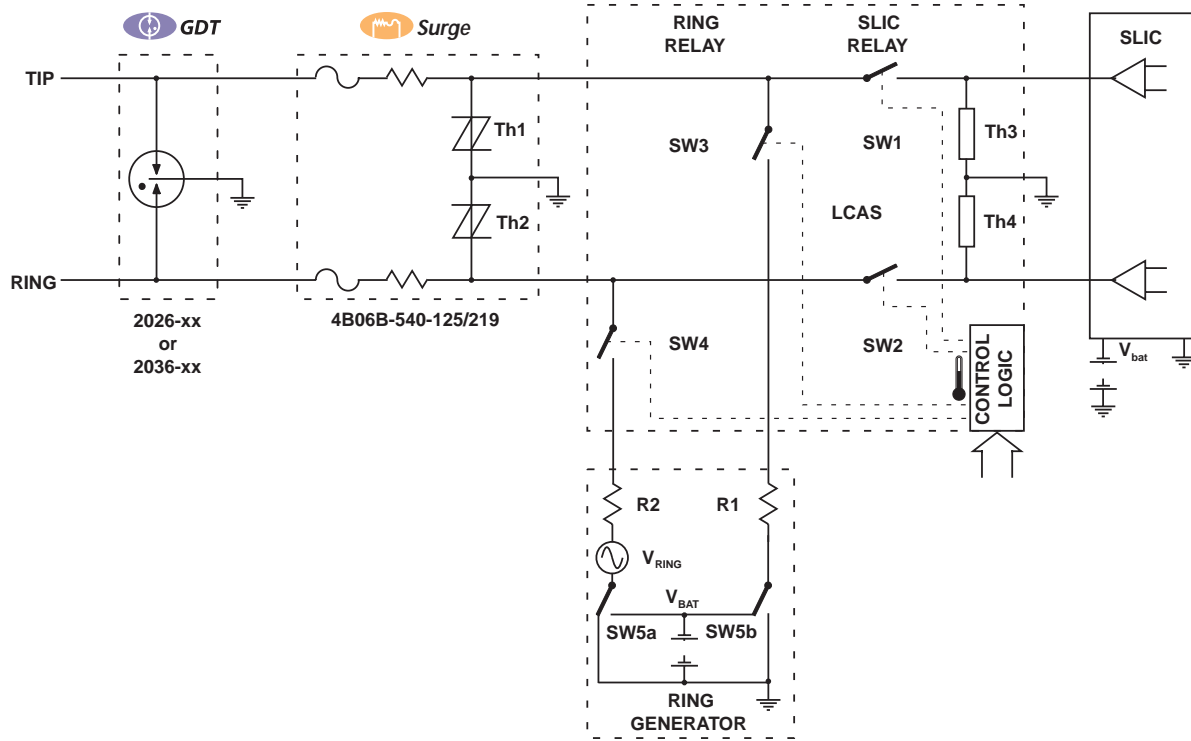

Linecard Protection with Solid-State Line Card Access Switch

Application - Customer Premise Equipment (CPE)

Unlike Central Office or Access applications, CPE connections are typically only 2-wire, removing the need to balance R and C on each line. Two key demands for CPE equipment relate to regenerated POTS lines and easy maintenance. As with CO applications, space-saving packaging is important for POTS SLIC protection. Thyristor-based devices offer the accuracy required with protectors matched to specific ICs or families simplifying the selection task.

CPE - Key Relevant Standards

	International	USA
Primary protection	ITU-T K.28 (Semiconductors) ITU-T K.12 (GDT) IEC 61643-311 (GDT)	GR-974 (Solid State & Hybrid) GR-1361 (GDT) RUS PE-80 (GDT) IEEE C62.31 (GDT) IEEE C62.32 (Carbon Block)
Secondary protection	ITU-T K.21 ITU-T K.22 (ISDN-S) ITU-T K.44 IEC 61000-4-5 (Intra-Building) IEC 61643-21	TIA/EIA-IS-968 (FCC Part 68) GR-1089-CORE (Intra-building)
Safety	IEC 60950	UL 1950 / 60950
ESD protection	IEC 61000-4-2	IEC 61000-4-2

CPE - Recent / Future Standards

As with CO and Access, the ITU-T standards have recently expanded significantly.

Organization	Standard	Comment
ITU-T	K.12, K.44 & K.21	New/Revised in 2000
	K.44	Revision anticipated
TELCORDIA	GR-974, GR-1089	Revised for 2002
EN/IEC	61643-311, -321, -341, -21	New for 2001
EN/IEC	MOV, Modules	Anticipated 2002-2004
FCC	TIA/EIA-IS-968 (FCC Part 68)	In revision for 2002
IEEE	C62.31, C62.32	In revision for 2003
	C62.37	Reaffirmed in 2002
ACTA	TIA/EIA-IS-968	New for 2001, Replaces FCC Part 68

CPE - Suitable Protection Technologies

	Primary	Secondary	
GDT	Y	H, L	Voltage Protection
Thyristor	U	Y	
MOV	H	Y	
TVS	H	Y	Current Protection
PTC Thermistor	Y	Y	
Fuse		Y	
Thermal Switch	Y		
Heat Coil	A		

- Y = Suitable
- A = Suitable except for ADSL and higher data rates
- H = Suitable as part of hybrid
- L = Suitable for LAN or ADSL use
- U = Suitable for urban high density deployment only

CPE - Relevant Sub-assemblies

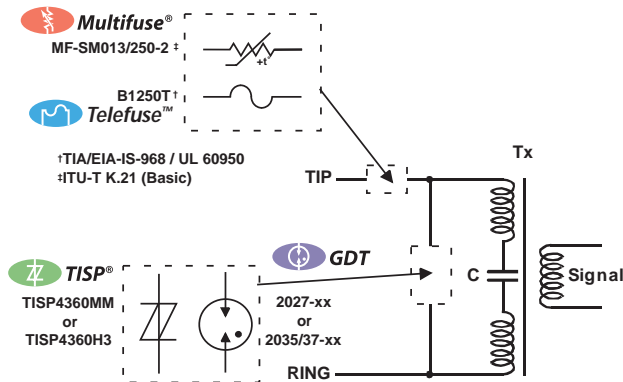

Basic ADSL Interface

CPE - Relevant Sub-assemblies (continued)

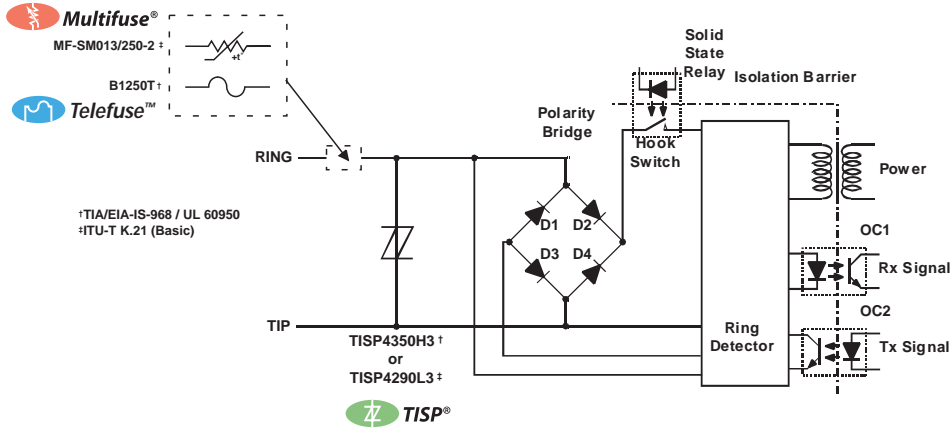

Basic Electronic Hook Switch Protection

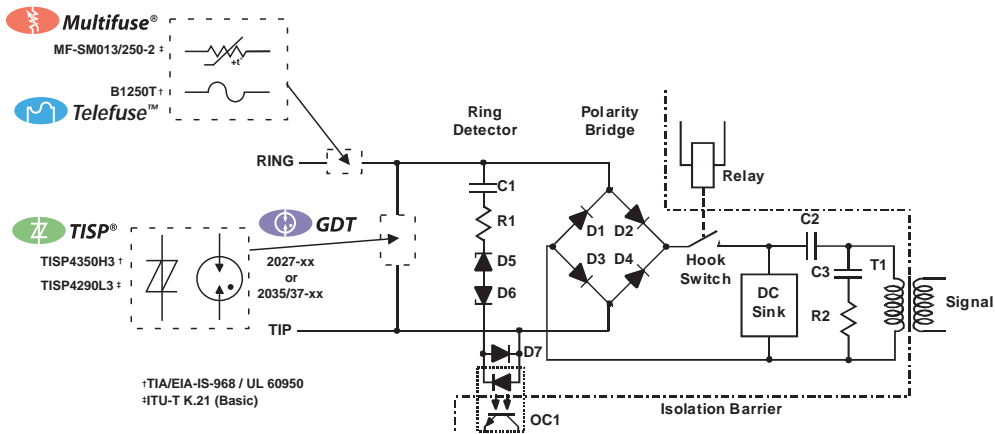

Basic Electromechanical Hook Switch Protection

Digital Technology

As bandwidth increases to meet escalating data transmission needs, absolute values of balance and insertion loss become important design considerations shown by Figure 12. In addition, balancing C and R for tip and ring, both at installation and over the longer term are important to minimizing EMC problems. This puts a premium on accuracy and stability, as well as relative value. However, series resistance attenuates the signal, reducing the practical transmission distance of xDSL, thereby making

resistance a performance consideration for xDSL. For this reason, fuses are often preferred over PTC thermistors for their lower resistance current protection despite the maintenance issue of being non-resetting. This underlines that hard rules are not feasible in protection since resetting devices would otherwise be ideal for CO and Access applications.

Similarly, since the capacitance of all semiconductors is voltage-dependent and this change of capacitance

may create harmonic distortion for digital signals and unbalance the line; careful selection is important. For the highest data rates, CAT5/100 MHz and above, GDTs are attractive.

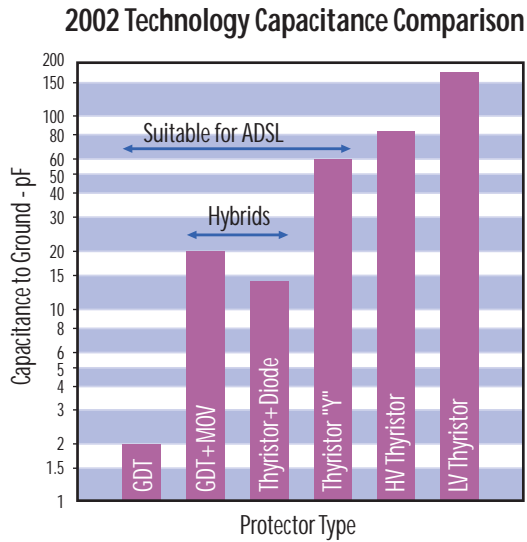

Figure 12. The value, stability and balance of capacitance and resistance are becoming vital for digital technologies

Performance Tip

R, C and L values of protection can be critical for digital lines. Balance and insertion loss are critical.

Datasheet Tip

Thyristor capacitance changes with applied voltage. Ensure that capacitance is stated for defined voltages, not just as a typical value.

Useful Sources

- IEC International Electrotechnical Committee
www.iec.ch

- IEEE Institute of Electrical and Electronic Engineers
www.ieee.com

- ETSI European Telecommunications Standards Institute
www.etsi.org

- FCC Federal Communication Commission
www.fcc.gov

- ITU International Telecommunications Union
www.itu.int

- JEDEC Joint Electron Device Engineering Council
www.jedec.org

- UL Underwriters Laboratories
www.ul.com

- TELCORDIA Telcordia Technologies (Formerly Bellcore) USA
www.telcordia.com

- TIA Telecommunications Industry Association
www.tiaonline.org

- ACTA Administrative Council for Terminal Attachments
www.part68.org



BOURNS®

Circuit Protection Solutions

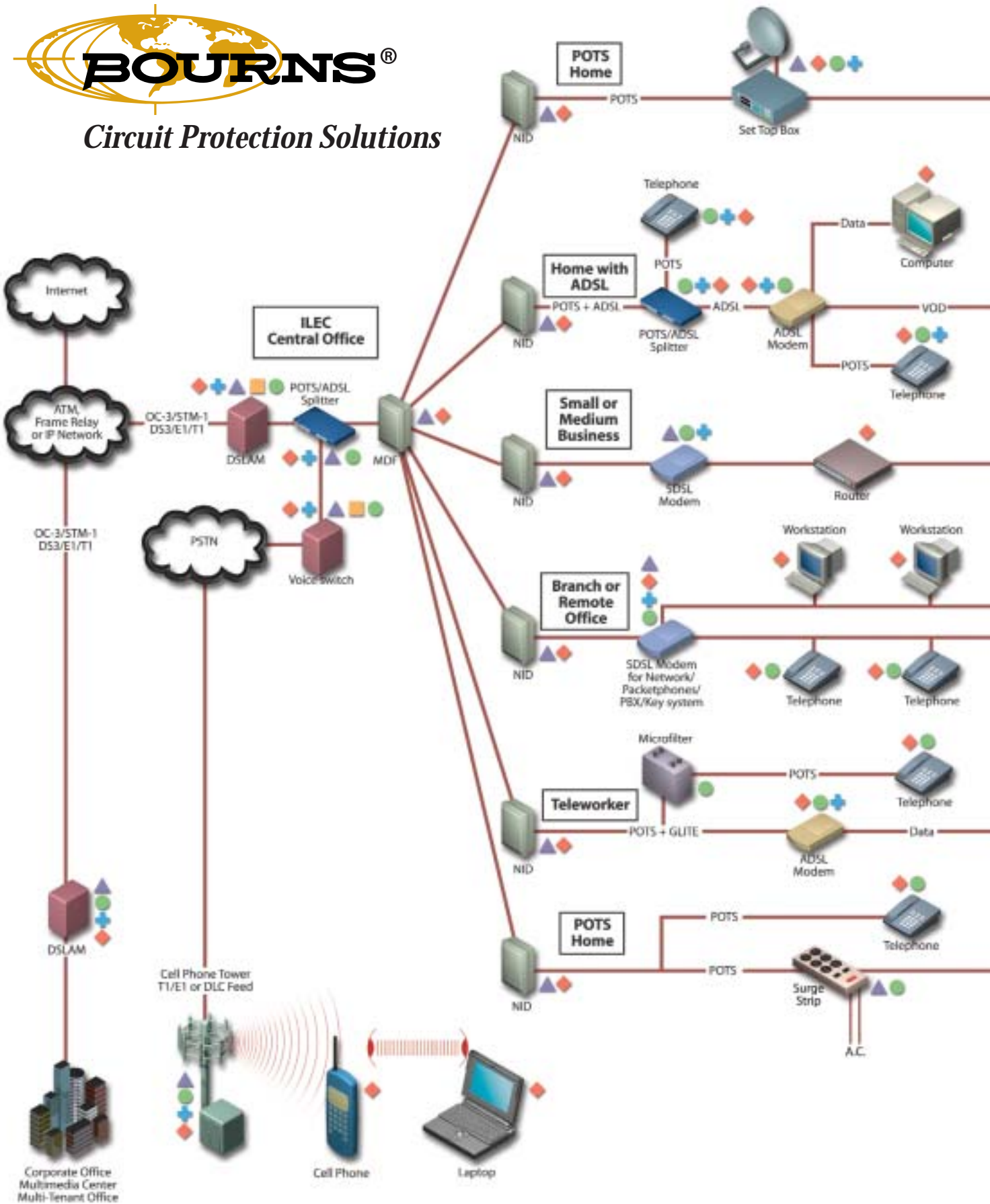

Network Diagram

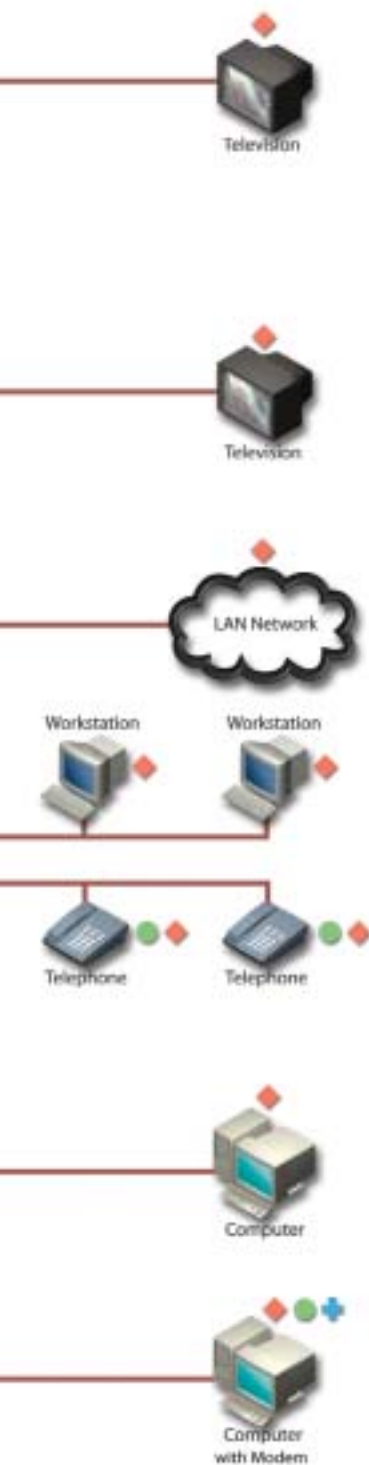

-   **GDT**
Gas Discharge Tubes
-   **Surge**
Line Protection Modules
-   **Telefuse™**
Telecom Fuses
-   **Multifuse®**
Resettable Fuses
-   **TISP®**
Thyristor Surge Protectors

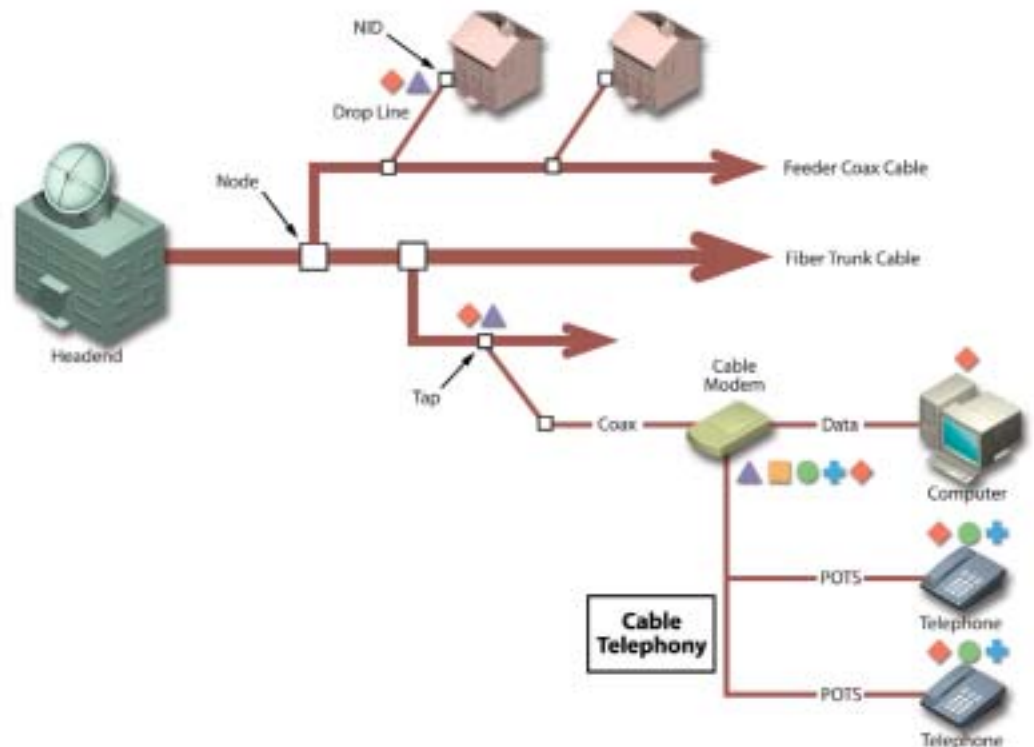

Which Protection Technology is Right for the Equipment?

No single protection technology offers an ideal solution for all requirements. Good protection design necessitates an understanding of the performance trade-offs and benefits of each device type, as well as the terminology used in their specifications. Adequate grounding and bonding, to reduce potential differences and provide a low impedance current path, is a prerequisite for coordinated system protection (GR-1089-CORE, Section 9).

The Basics – Overvoltage and Overcurrent

Protection devices fall into two key types, overvoltage and overcurrent. Overvoltage devices (see Figure 1) divert fast surge energy (such as lightning), while most overcurrent devices (see Figures 2a-2c) increase in resistance to limit the surge current flowing from longer duration surge currents (50/60 Hz power cross). There are two types of voltage limiting protectors: switching devices (GDT and Thyristor) that crowbar the line and clamping devices (MOV and TVS). The inset waveforms of Figure 1 emphasize that switching devices results in lower stress levels than clamping devices (shaded area) for protected equipment during their operation. Functionally, all voltage protectors reset after the surge, while current protectors may or may not, based on their technology. For example, PTC thermistors are resettable; fuses are non-resettable as shown in Table 1.

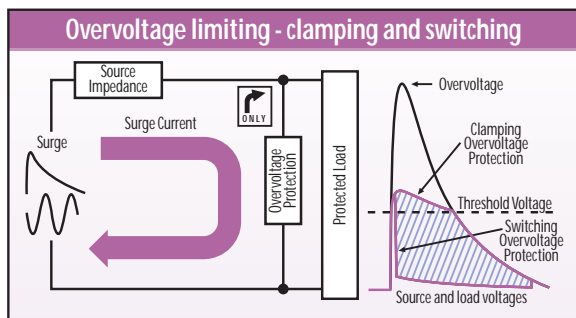

Figure 1. Overvoltage protection provides a shunt path for surges

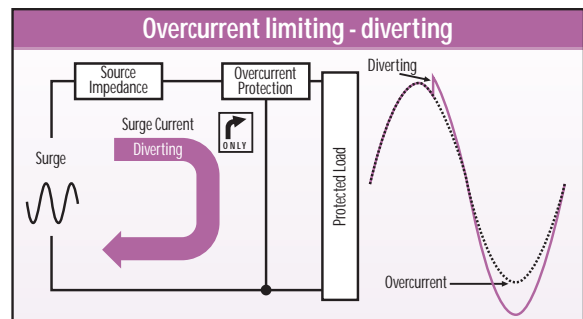
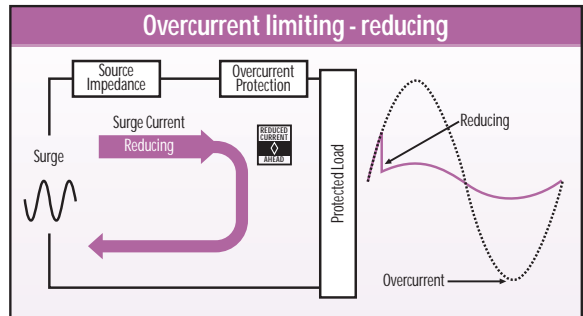
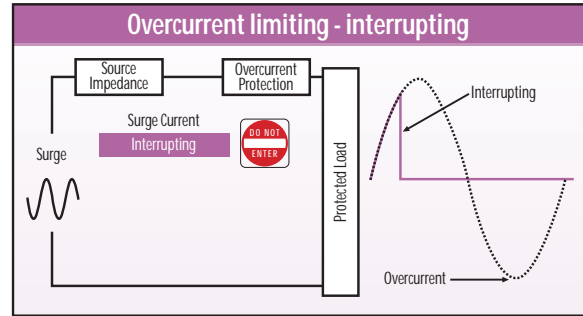

Figure 2a-2c. Overcurrent protection isolates the equipment by presenting a high impedance

What Happens After a Surge or if the Device Fails?

In addition to preventing a surge from destroying equipment, resettable devices return the equipment to pre-event operation, eliminating maintenance cost and maximizing communications service. In addition, lightning typically consists of multiple strikes. It is, therefore, essential to consider subsequent surges. Because lightning and power cross standards are not intended to represent the maximum surge amplitudes in the field, an understanding of what happens under extreme conditions is equally important.

Overvoltage

Action	Connection	Examples
Voltage switching	Shunt	GDT, Thyristor
Voltage clamping	Shunt	MOV, TVS

Overcurrent

Action	Connection	Examples
Resettable	Series	PTC thermistor - Ceramic - Polymer
Non-resettable	Series	Fuse
Non-resettable	Shunt or Series	Heat coil
Non-resettable	Series	LFR (Line Feed Resistor)
Non-resettable	Across voltage limiter	Fail-short device for thermal overload

Table 1. The basic classes of protection devices

A shunt device failing open circuit effectively offers no follow-on protection, although under normal conditions the telephone line will operate. If the device fails to a short circuit, the line is out of service, but further damage is prevented. In addition, other issues such as exposed areas prone to heavy surge events or remote installations where maintenance access is difficult may strongly influence selection of the most suitable protection technology (see Table 2).

Reliability Tip

Complying with standards does not guarantee field reliability.

Speed and Accuracy are Major Factors in Determining Equipment Stress Levels

The behavior of each technology during fast surge events can have a substantial effect on maximum stress as summarized in Table 3. In addition to device tolerance, each device requires a finite time to operate, during which the equipment is still subjected to the rising surge waveform. Before operation, some

Overvoltage

	Suitable for Primary (P) or Secondary (S) ^{1,2}	Normal Operation	After Excess Stress ³	
		After Operation	Still Protecting?	Line Operating?
GDT	P or S	Reset to Normal	Yes/No	No/Yes
GDT + Thermal Switch	P	Reset to Normal	Yes	No
Thyristor	P or S	Reset to Normal	Yes	No
Thyristor + Thermal Switch	P	Reset to Normal	Yes	No
MOV	S	Reset to Normal	No	Yes
TVS	S	Reset to Normal	Yes	No

Overcurrent

	Normal Operation	After Excess Stress ³	
	After Operation	Still Protecting?	Line Operating?
PTC Thermistor	Reset to Normal	Yes	No
Fuse	Line Disconnected	Yes	No
Heat Coil	Line Shorted or Open	Yes	No
Thermal Switch	Line Shorted	Yes	No
LFR	Both Lines Disconnected	Yes	No

¹ Primary protection applications typically require specific fail-short protection.

² Secondary protection requires a fused line (USA).

³ The failure mode depends on the extent of the excess stress. Comments made for a typical condition that does not fuse leads.

Table 2. The status after the protection has operated can be a significant maintenance/quality of service issue

Overvoltage Limiters

Type		Performance			
Class	Technology	Voltage Limiting Speed	Voltage Precision	Impulse Current Capability	Low Capacitance
Switching	Gas Discharge Tube	▶	➔	➔ BEST	➔ BEST
	Thyristor	➔	➔	➔	➔
Clamping	Metal-Oxide Varistor	➔	▶	➔	➔
	TVS	➔ BEST	➔ BEST	▶	▶

Table 3a. No overvoltage technology offers an ideal solution for all applications

Overcurrent Limiters

Type		Performance			
Class	Technology	Fast Operation	Resistance Stability	Low Operating Current	Low Series Resistance
Reducing	Polymer PTC Thermistor	➔ BEST	▶	➔ BEST	➔
	Ceramic PTC Thermistor	➔ BEST	➔	➔ BEST	▶
Interrupting	Fuse	➔	➔ BEST	➔	➔ BEST
	Line Feed Resistor	▶	➔ BEST	▶	▶
Diverting	Heat Coil	➔	➔	➔ BEST	➔
	Thermal Switch	▶	➔ BEST	▶	➔ BEST

Table 3b. No overcurrent technology offers an ideal solution for all applications

technologies allow significant overshoot above the 'operating' level. The worst-case effects determine the stress seen by the equipment and not just the nominal "protection" voltage or current (see Figure 3).

Overvoltage protection technologies may be summarized as follows:

- GDTs offer the best AC power and high surge current capability. For high data rate systems (>30 Mbs), the low capacitance makes GDTs the preferred choice.
- Thyristors provide better impulse protection, but at a lower current.
- MOVs are low cost components.
- TVS offers better performance in low dissipation applications.

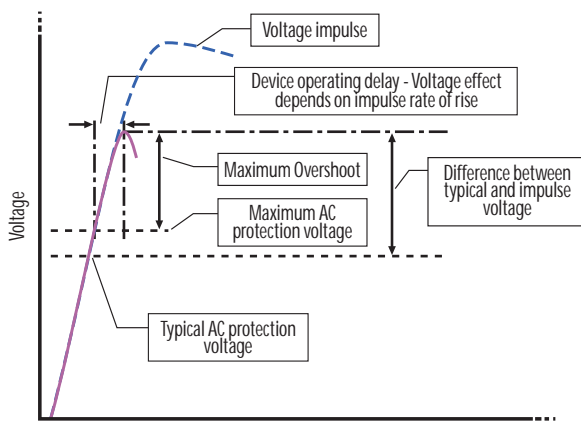

Figure 3. Systems must survive more than the nominal protection voltage

Overcurrent protection technologies may be summarized as follows:

- PTC thermistors provide self-resetting protection.
- Fuses provide good overload capability and low resistance.
- Heat coils protect against lower level 'sneak currents'.
- LFRs provide the most fundamental level of protection, combined with the precision resistance values needed for balanced lines and are often combined with other devices.

Reliability Tip
Check worst-case protection values, not just nominal figures.

Technology Selection - Overvoltage Protectors

Voltage limiting devices reduce voltages that exceed the protector threshold voltage level. The two basic types of surge protective devices are clamping and switching, Figure 8. Clamping type protectors have a continuous voltage-current characteristic (MOV and TVS), while the voltage-current characteristic of the switching type protector is discontinuous (GDT and

Thyristor). A series or shunt combination of clamping and switching type devices may provide a better solution than a single technology.

Utilize the decision trees in Figures 4-7 to aid in the selection of a suitable circuit protection solution. Comparative performance indicators and individual device descriptions beneath each decision tree allow designers to evaluate the relative merits for each individual or combination of technologies.

The lower density and increased exposure of rural sites suggests that heavier surges can be expected for

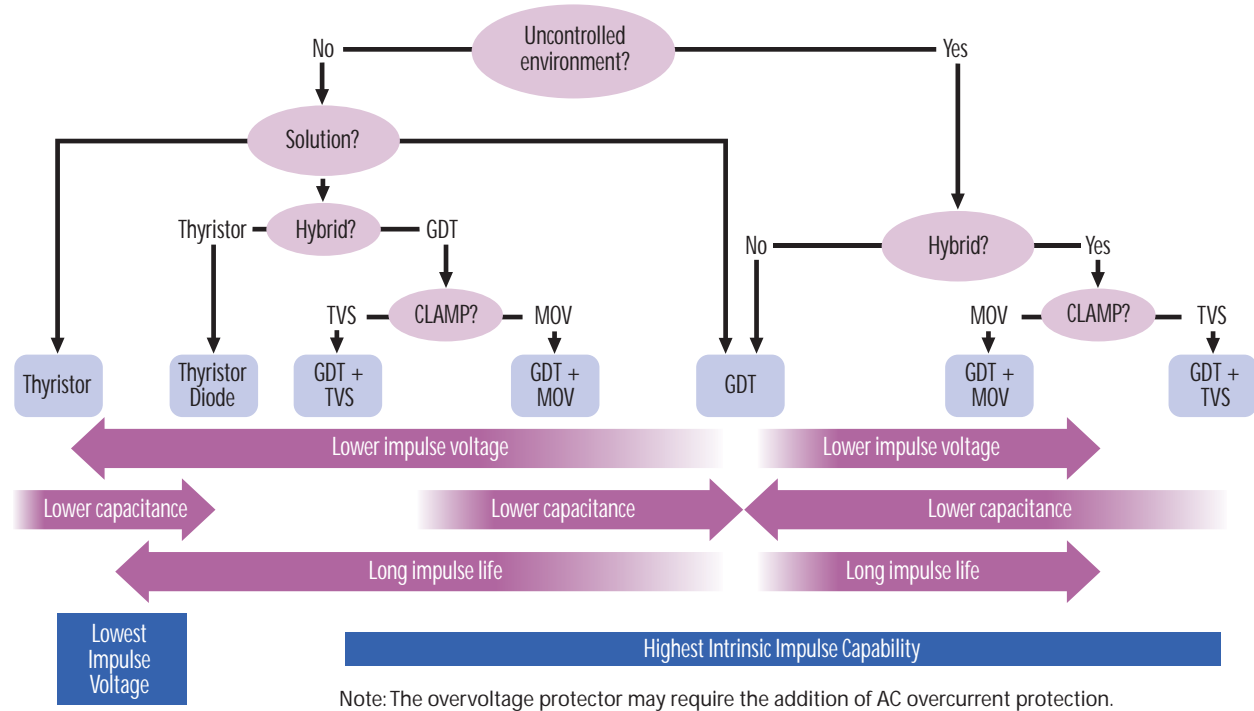

Figure 4. Primary overvoltage technology selection

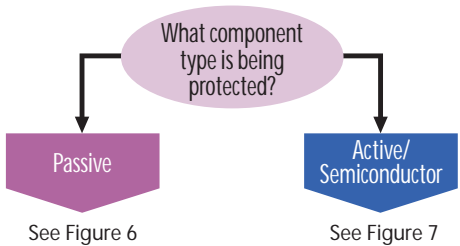
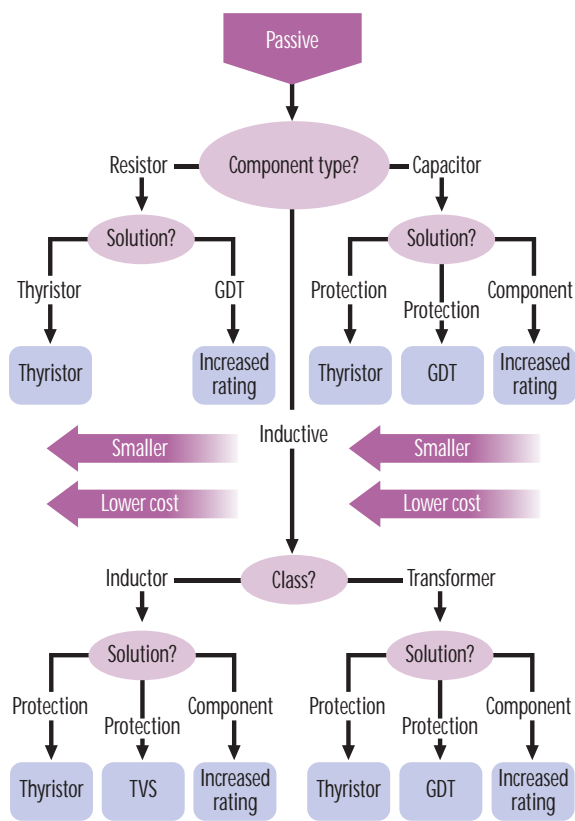

Figure 5. Secondary overvoltage protection depends on the type of component to be protected

these applications (Figure 4), while the cost and type of the protected equipment has an influence on the selection of secondary protection (Figure 5, 6, & 7). During the operation of overvoltage protectors, surge currents can be very high and PCB tracks and system grounding regimes must be properly dimensioned.

Reliability Tip
Ensure that PCB tracks and wiring are dimensioned for surge currents.



Note: The overvoltage protector may require the addition of AC overcurrent protection.

Figure 6. Secondary protection of passive components

It is important that protectors do not interfere with normal operation. Although traditional telecom systems typically run at -48 V battery voltage plus 100 V rms ringing voltage (i.e. approximately 200 V peak), designers should consider worst-case battery voltage, device temperature, and power induction voltages when specifying minimum protection voltage. Some digital services operate at much higher span voltages, requiring further consideration for equipment designed for broadband applications (see Table 3 in the Applications section).

The capacitance of overvoltage protectors connected across these lines is important - especially for digital connections such as

ISDN and xDSL. Matched and stable devices are necessary to avoid introducing imbalance in the system.

Datasheet Tip
When protecting digital lines, check the tolerance and variation of protection capacitance (i.e. voltage dependence), not just nominal values.

Gas Discharge Tubes (GDTs)

GDTs apply a short circuit under surge conditions, returning to a high impedance state after the surge. These robust devices with negligible capacitance are attractive for protecting digital lines. GDTs are able to handle significant currents, but their internal design can significantly affect their operating life under large surges (see Figure 9). GDTs are sensitive to the rate of rise of voltage surges (dv/dt), which increase the Sparkover Voltage under fast impulse conditions up to double that of AC conditions. Their ability to handle very high surge currents for hundreds of microseconds and high AC for many

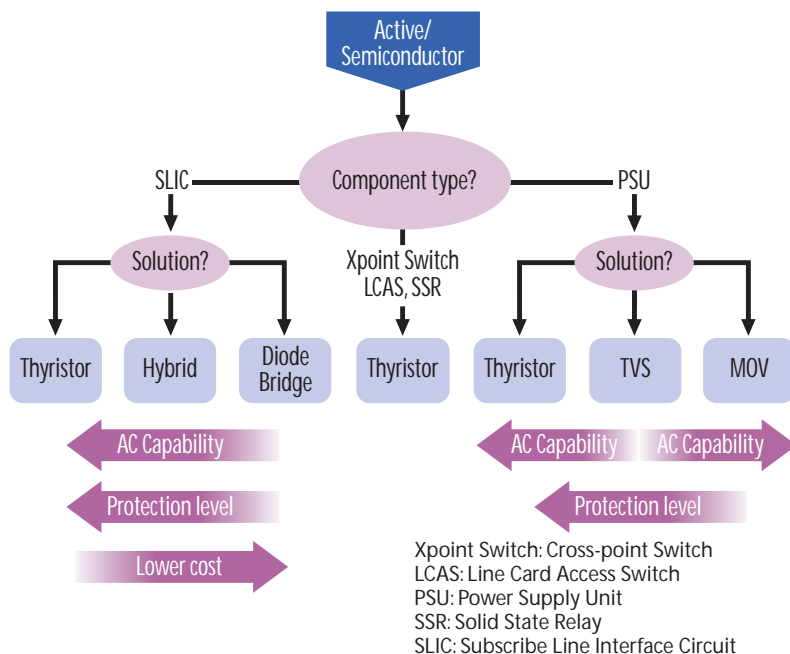

Note: The overvoltage protector may require the addition of AC overcurrent protection, such as a LFM, PTC thermistor or fuse.

Figure 7. Secondary protection of active components

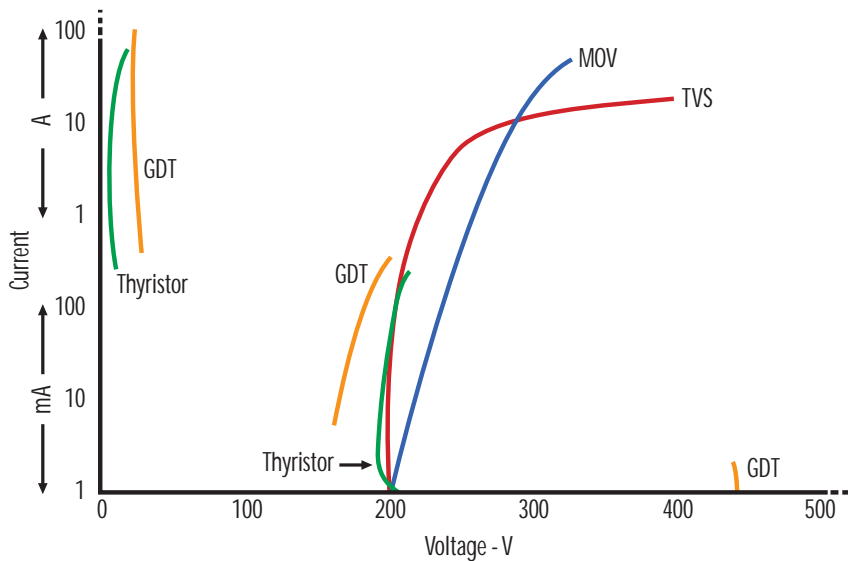

Figure 8. Overvoltage protectors feature very different V/I characteristics

Certain GDTs can suffer from venting or gas loss. To ensure protection under these circumstances, an air Back Up Gap (BUG) has been used. BUGs themselves can be subject to moisture ingress or contamination, reducing their operating voltage, and leading to nuisance tripping. BUGs are also more sensitive to fast rising voltage surges, causing the BUG to operate instead of the GDT. All Bourns GDTs are now UL approved for use without the need of a BUG, eliminating extra cost and improving reliability (see Figure 10).

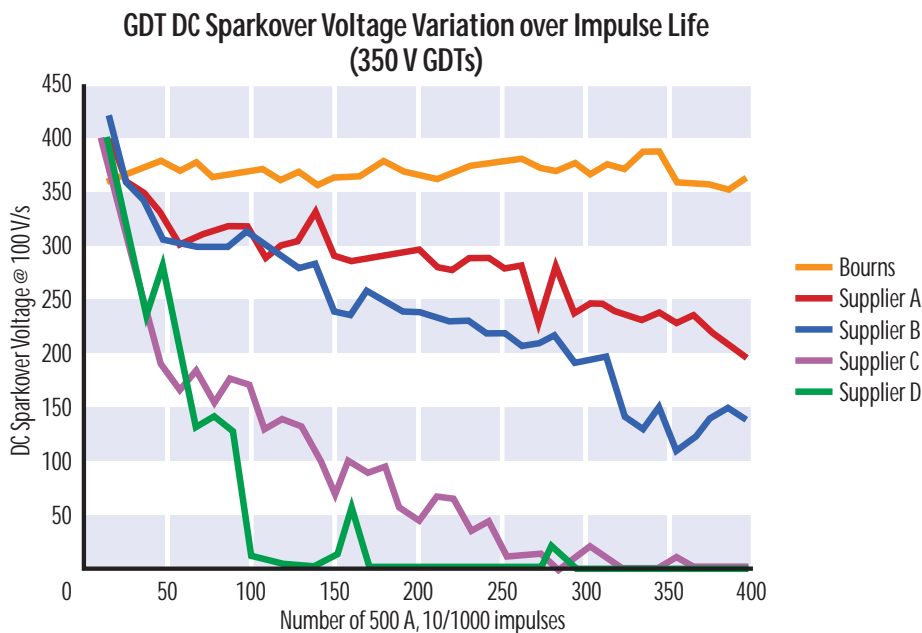



Figure 9. GDT behavior may deteriorate under real-world field conditions

seconds matches the primary protection needs of exposed and remote sites. During prolonged AC events, GDTs can develop very high temperatures, and should be combined with a thermal overload switch that mechanically shorts the line (Switch-Grade Fail-Short mechanism).

Datasheet Tip
GDTs are available with Switch-Grade Fail-Short Device.

Standards Tip
UL Recognized GDTs are now available, requiring no BUG.

Bourns Products

 **GDT**
Gas Discharge Tubes

Bourns offers the subminiature 3-electrode Mini-TRIGARD® and the 2-electrode Mini-GDT. Combining small size with the industry's best impulse life, these products are ideal for high-density primary applications.

Surge Current	Power Cross	dv/dt Sensitivity	di/dt Sensitivity	Typical Application
Several kA for 100 μ s	Several amps for seconds	Poor	None	Primary and secondary protection Exposed sites Sensitive equipment needs additional secondary protection Particularly suited to high speed digital lines

to handle moderate currents without a wear-out mechanism. The disadvantages of thyristor protectors are higher capacitance, which is a limitation in high-speed digital applications, and less tolerance of excessive current. Thyristor

GDT protection capabilities

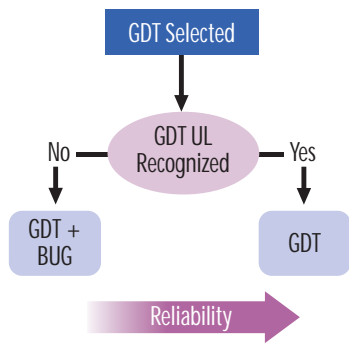

UL Recognized GDTs no longer need a BUG (air Back Up Gap)

Figure 10. Traditional GDT venting has required back-up protection

Thyristor-Based Devices

Thyristor-based devices initially clamp the line voltage, then switch to a low-voltage “On” state. After the surge, when the current drops below the “holding current,” the protector returns to its original high impedance state. The main benefits of thyristor protectors are lower voltage overshoot and an ability

protectors can act either as secondary protection in conjunction with GDTs, or as primary protection for more controlled environments/ lower surge amplitudes. For protection in both voltage polarities, either a power diode or second thyristor may be integrated in inverse parallel, creating versatile protection functions that may be used singly or in various combinations. The clamping voltage level of fixed voltage thyristors is set during the manufacturing process. Gated thyristors have their protective level set by the voltage applied to the gate terminal.

Bourns Products

TISP®
Thyristor Surge Protectors

The TISP® family of thyristor-based devices includes an extensive range of single and multiple configurations in unidirectional and bidirectional formats, with fixed or gated operation.

Metal Oxide Varistors (MOVs)

A Metal Oxide Varistor (variable resistor) is a voltage dependent resistor whose current predominantly increases exponentially with increasing voltage. In clamping surges, the MOV absorbs a substantial amount of the surge energy. With a high thermal capacity, MOVs

Surge Current	Power Cross	dv/dt Sensitivity	di/dt Sensitivity	Typical Application
Several 100 A for 100 μ s	Several amps for seconds	Good	Poor	Primary or secondary protection Urban and some exposed sites Can protect sensitive equipment

Thyristor protection capabilities

have high energy and current capability in a relatively small size. MOVs are extremely fast and low cost, but have high capacitance, a high, current-dependant clamping voltage, and are susceptible to wear.

Surge Current	Power Cross	dv/dt Sensitivity	Typical Application
Several kA for 100 μ s	Dissipation limited	Good	Secondary protection Can protect non-sensitive equipment

MOV protection capabilities

Typical MOV applications include general-purpose AC protection or low-cost analog telecom equipment such as basic telephones. When combined with a GDT, the speed of the MOV enables it to clamp the initial overshoot while the GDT begins to operate. Once the GDT fires, it limits the energy in the MOV, reducing the size of MOV required. Devices are available which integrate an MOV and GDT in a single package to simplify assembly and save space.

Datasheet Tip

When selecting operating voltage, remember that MOV residual voltage increases considerably at higher current.

Transient Voltage Suppressors

Transient Voltage Suppressor (TVS) diodes are sometimes called Zeners, Avalanche or Breakdown Diodes, and operate by rapidly moving from high impedance to a non-linear resistance characteristic that clamps surge voltages. TVS diodes provide a fast-acting and well-controlled clamping voltage which is much more precise than in an MOV, but they exhibit high capacitance and low energy capability, restricting the maximum surge current. Typically used for low power applications, their well-

Surge Current	Power Cross	dv/dt Sensitivity	Typical Application
Low	Poor	None	Secondary protection Can protect sensitive equipment

TVS protection capabilities

controlled voltage clamp enables the selection of protection voltages closer to the system voltage, providing tighter protection.

Technology Selection - Overcurrent Protectors

Current limiting devices (See Figures 11, 12) provide a slow response, and are primarily aimed at protection from surges lasting hundreds of

milliseconds or more, including power induction or contact with AC power. By combining a fixed resistor in series with a resettable protector, an optimum balance of nominal resistance and operating time is obtained. The inherent resistance of certain overcurrent protectors can also be useful in coordination between primary and secondary overvoltage protection.

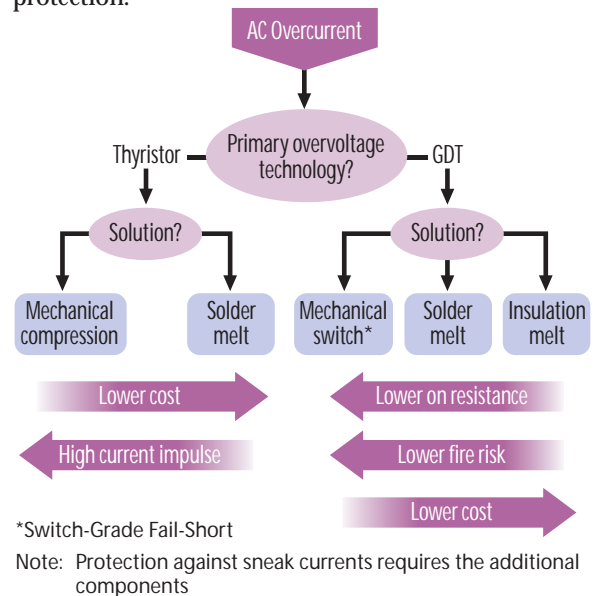

Figure 11. Selection of fail-short technology for Primary overvoltage protection

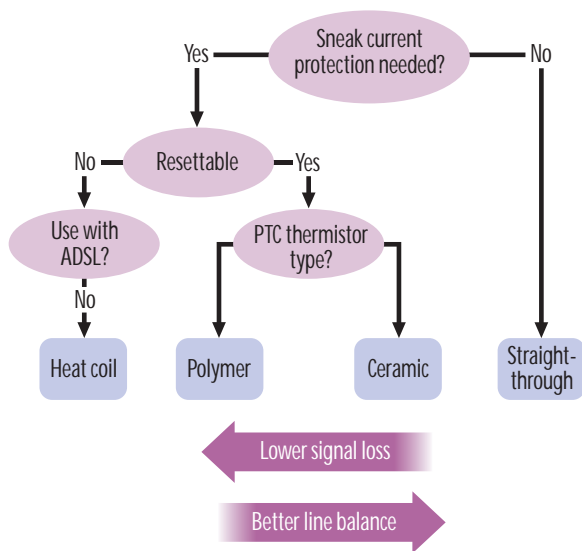

Figure 12. Sneak current technology selection

Reliability Tip

Hybrid devices incorporating resistors can improve performance.

Positive Temperature Coefficient (PTC) Thermistors

Heat generated by current flowing in a PTC thermistor causes a step function increase in resistance towards an open circuit, gradually returning close to its original value once the current drops below a threshold value. The stability of resistance value after surges over time is a key issue for preserving line balance. PTCs are commonly referred to as resettable fuses, and since low-level current faults are very common, automatically resettable protection can be particularly important. There are two types of PTC thermistors based on different underlying materials: Polymer and Ceramic. Generally the device cross-sectional area determines the surge current capability, and the device thickness determines the surge voltage capability.

Polymer PTC devices typically have a lower resistance than ceramic and are stable with respect to voltage and temperature. After experiencing a fault condition, a change in initial resistance may occur. (Resistance is measured one hour after the fault condition is removed and the resulting change in resistance compared to initial resistance is termed the R1 jump.)

In balanced systems with a PTC thermistor in each conductor, resistance change may degrade line balance. Including additional series resistance such as an LFR can reduce the effect of the R1 jump. In addition, some PTC thermistors are available in resistance bands to minimize R1 effects. Polymer types are also commonly used singly to protect CPE equipment.

Ceramic PTC devices do not exhibit an R1 jump, and their higher resistance avoids the need for installing an additional LFR. While this reduces component count, the resistance does vary with applied voltage. Since this change can be substantial (e.g. a decrease by a factor of about 3 at 1 kV), it is essential that any secondary overvoltage protection be correctly rated to handle the resulting surge current, which can be three times larger than predicted by the nominal resistance of the ceramic PTC. In a typical line card application, line balance is critical.

Reliability Tip

The stability of PTC thermistor resistance after operation can be critical for line balance.

	Nominal Ohms	Resistance Stability (with V and Temperature)	Change After Surge	Typical Application
Polymer PTC Thermistor	0.01 - 20	Good	10-20 %	CPE Equipment, e.g. Modem
Ceramic PTC Thermistor	10 - 50	R decreases with temperature and under impulse	Small	Balanced line, e.g. Line Card SLIC

Table 4. The two types of PTC thermistors have important differences

Datasheet Tip

PTC thermistor and resistor hybrids can improve speed and line balance.

Bourns Products



Bourns offers an extensive range of polymer PTC devices in the Multifuse® resettable fuse product family, providing resettable overcurrent protection solutions.

Bourns Products



Bourns has recently launched the B1250T/B0500T range of SMT power fault protection fuses.

Fuses

A fuse heats up during surges, and once the temperature of the element exceeds its melting point, the normal low resistance is converted to an open circuit. The low resistance of fuses is attractive for xDSL applications, but their operation is relatively imprecise and time-dependant. Once operated, they do not reset. Fuses also require additional resistance for primary coordination (see Application section).

Since overvoltage protection usually consists of establishing a low impedance path across the equipment input, overvoltage protection itself will cause high currents to flow. Although relatively slow acting, fuses can play a major safety role in removing longer-term faults that would damage protection circuitry, thus reducing the size and cost of other protection elements. It is important to consider the I-t performance of the selected fuse, since even multiples of the rated current may not cause a fuse to rupture except after a significant delay. Coordination of this fuse behavior with the I-t performance of other protection is critical to ensuring that there is no combination of current-level and duration for which the protection is ineffective. By including structures intended to

Safety Tip

Fuses offer a simple way to remove long-term faults, and potentially dangerous heat generation, but I-t coordination with other protection is vital.

rupture under excess current conditions or separate components, it is also possible to produce hybrid fusible resistors.

Heat Coils

Heat coils are thermally activated mechanical devices connected in series with the line being protected, which divert current to ground. A series coil operates a parallel shunt contact, typically by melting a solder joint that is restraining a spring-loaded contact. When a current generates enough heat to melt the joint, the spring mechanically forces two contacts together, short-circuiting the line. Heat coils are ideal to protect against “sneak currents” that are too small to be caught by other methods. Their high inductance makes them unsuitable for digital lines. It is also possible to construct current interrupting heat coils which go open circuit as a result of overcurrent.

Line Feed Resistors

A Line Feed Resistor (LFR) is the most fundamental form of current protection, normally fabricated as a thick-film device on a ceramic substrate. With the ability to withstand high voltage impulses without breaking down, AC current interruption occurs when the high temperature developed by the resistor causes mechanical expansion stresses that result in the ceramic breaking open. Low current power induction may not break the LFR open, creating long-term surface temperatures of more than 300 °C. To avoid heat damage to the PCB and adjacent components, maximum surface temperature can be limited to about 250 °C by incorporating a series thermal link fuse on the LFR. The link consists of a solder alloy that melts when high temperatures occur for periods of 10 seconds or more. Along with the high precision needed for balanced lines, LFRs have

significant flexibility to integrate additional resistors, multiple devices, or even different protection technology within a single component. One possible limitation is the need to dimension the LFR to handle the resistive dissipation under surge conditions.

Along with combining multiple non-inductive thick-film resistors on a single substrate to achieve matching to <1 %, a resistor can be combined with other devices to optimize their interaction with the overall protection design. For example, a simple resistor is not ideal for protecting a wire, but combining a low value resistor with another overcurrent protector provides closer protection and less dissipation than either device can offer alone. Both functions can be integrated onto a single thick-film component using fusible elements, PTC thermistors, or thermal fuses. Similarly, more complex hybrids are available, adding surface mount components such as thyristor protectors, to produce coordinated sub-systems.

Bourns Products



Line Protection Modules

Bourns offers Line Feed Resistors combining matched resistor pairs plus thermal link fuses.

Thermal Switches

These switches are thermally activated, non-resetting mechanical devices mounted on a voltage-limiting device (normally a GDT). There are three common activation technologies: melting plastic insulator, melting solder pellet or a disconnect device. Melting occurs as a result of the temperature rise of the voltage-limiting device's thermal overload condition when exposed to a continuous current flow. When the switch operates, it shorts out the voltage-limiting device, typically to ground, conducting the surge current previously flowing through the voltage-limiting device.

A plastic-melting based switch consists of a spring with a plastic insulator that separates the spring contact from the metallic conductors of the voltage-

limiting device. When the plastic melts, the spring contacts both conductors and shorts out the voltage-limiting device.

A solder-pellet-melting based switch consists of a spring mechanism that separates the line conductor(s) from the ground conductor by a solder pellet. In the event of a thermal overload condition, the solder pellet melts and allows the spring contacts to short the line and ground terminals of the voltage-limiting device.

A "Snap Action" switch typically uses a spring assembly that is held in the open position by a soldered standoff and will short out the voltage-limiting device when its switching temperature is reached. When the soldered connection melts, the switch is released and shorts out the line and ground terminals of the voltage limited (Bourns US Patent #6,327,129).

Modes of Overvoltage Protection

Insufficient protection reduces reliability, while excessive protection wastes money, making it vital to match the required protection level to the equipment or component being protected. One important aspect is the "modes" of protection. Figure 13 illustrates that, for two wire systems, a single mode of operation protects against transverse (differential/metallic) voltages, but for three wire systems, the ground terminal provides opportunities to protect against both transverse and longitudinal (common-mode) surges. This offers a trade-off for items such as modems, where the provision of adequate insulation to ground for longitudinal voltages enables simple single mode/single device protection to be used. Ground-referenced SLICs and LCAS ICs, however, require three-mode protection.

Figure 14 illustrates how devices may be combined and coordinated to offer three-mode protection. The three-wire GDT offers two modes of robust primary protection, while two PTC devices provide decoupling and coordination. The bi-directional thyristor provides the third mode of precise secondary voltage protection.

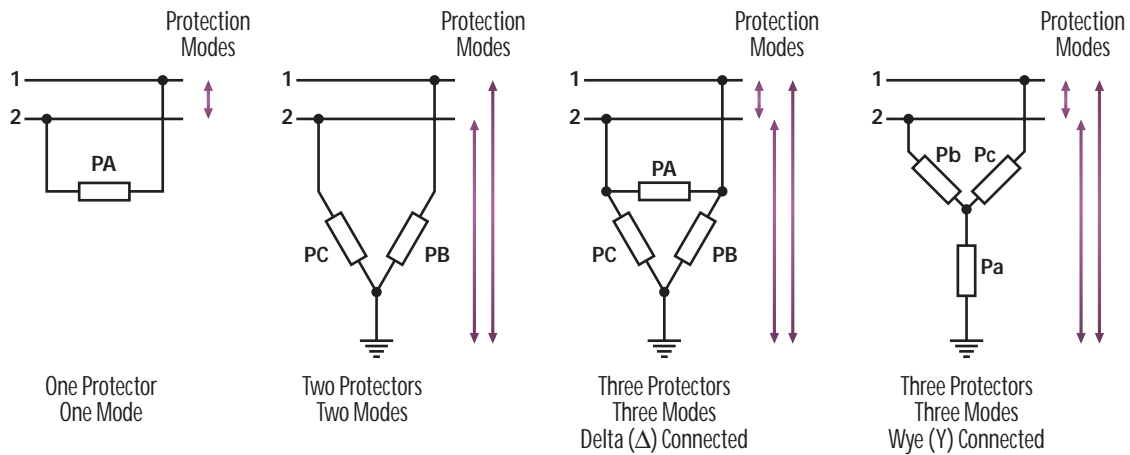

Figure 13. Matching the modes of protection to the application optimizes protection and cost

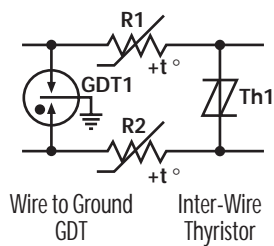

Figure 14. The modes of protection may be split between primary and secondary devices, with PTC thermistors ensuring coordination

Technology Selection - Integrated Solutions

As emphasized earlier, no single technology provides ideal protection for all requirements. Combining more than one technology can often provide an attractive practical solution. Clearly the convenience of a single component/module combining multiple devices saves space and assembly cost while simplifying the design task (see Figure 15). In addition, some integrated modules provide performance and capabilities that cannot be achieved with separate discrete devices. In the next sections, multi-stage

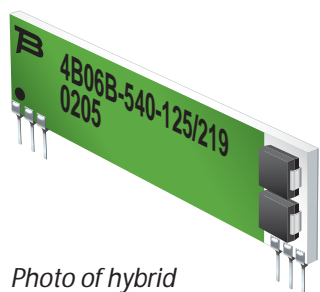

Figure 15. Photo of hybrid

overvoltage protectors and a broader combination of overvoltage and overcurrent protection integrated line protection modules are presented.

Multi-Stage Protectors

When considering overvoltage protection (see Figure 4), combining a GDT with either a TVS or MOV clamping device can reduce the impulse voltage stress seen by downstream components. Although TVS devices are attractive, they often introduce too much capacitance. Typically, a GDT/MOV combination offers a better solution. Figure 16 illustrates the different behavior of GDTs, GDT/MOV hybrids and Thyristor overvoltage protection for both 100 V/μs and 1000 V/μs impulse waveforms. The GDT/MOV hybrid provides more consistent protection than a simple GDT, irrespective of the environment.

The low capacitance of the GDT/MOV hybrid also provides valuable characteristics for high frequency applications, enabling the protection of a wide range of copper-pair lines from POTS to VDSL and CAT5 100 Mb/s networks. All Bourns, GDT and GDT/MOV hybrid families are UL Recognized for use without a BUG, making them simple to use and saving valuable space. In addition to its superior clamping of fast rising transients, the MOV of the GDT/MOV assembly provides the function of a back up device without the well-known negative side effects of BUGs. Figure 11 demonstrates that a thermally operated current diverter is useful to protect the GDT

from excessive heat dissipation under prolonged power cross conditions. The best performance and lowest fire risk are provided by the thermal switch or switch-grade fail-short mechanism. GDT/MOV/fail-short overvoltage protectors effectively replace three components, providing maximum surge current capability from the GDT, low transient clamping characteristics and back up function from the MOV, and maximum safety from the switch-grade fail-short device.

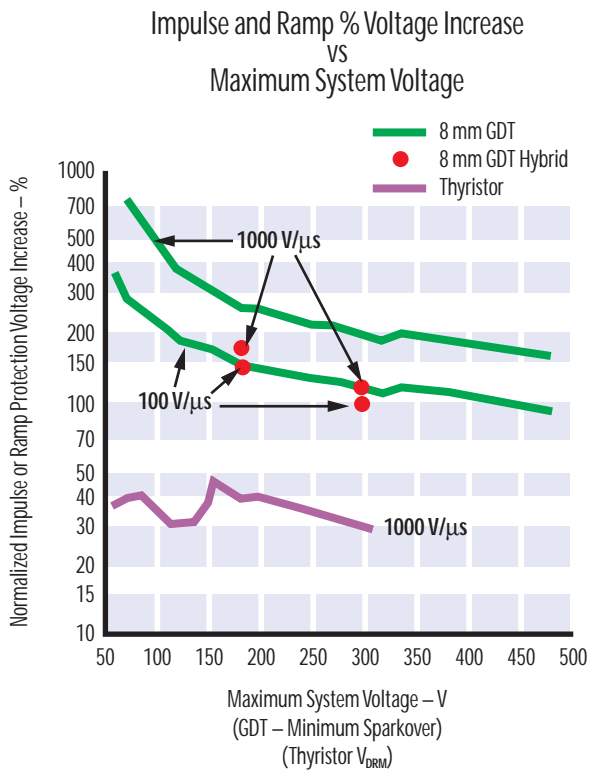

Figure 16. Each protection technology behaves differently under Impulse conditions

Bourns Products

GDT
 Gas Discharge Tubes

The Bourns MSP® Multi-Stage Protector assembly combines MOV responsiveness with GDT robustness. Combined with our patented switch-grade fail-short device, it provides the optimum broadband network primary protection solution.

Integrated Line Protection Modules

Integrating multiple protection elements on a single FR4 or ceramic substrate SIP reduces the PCB area taken and increases the number of lines that can be fitted to each line card. Figure 17 outlines the key technologies available for such integrated assemblies and introduces one new form of overcurrent protection. Thermal Link Fuses use the heat from the LFR under continuous power induction to desolder a series link, which interrupts the induced current, avoiding thermal damage to the module, the line card or surrounding components. They are not practical as discrete devices because they use special structures built into the substrate. These integrated modules tend to be customized for each application, rather than off-the-shelf components.

Although PTC thermistors may be used alone, series connection with an LFR reduces peak currents and

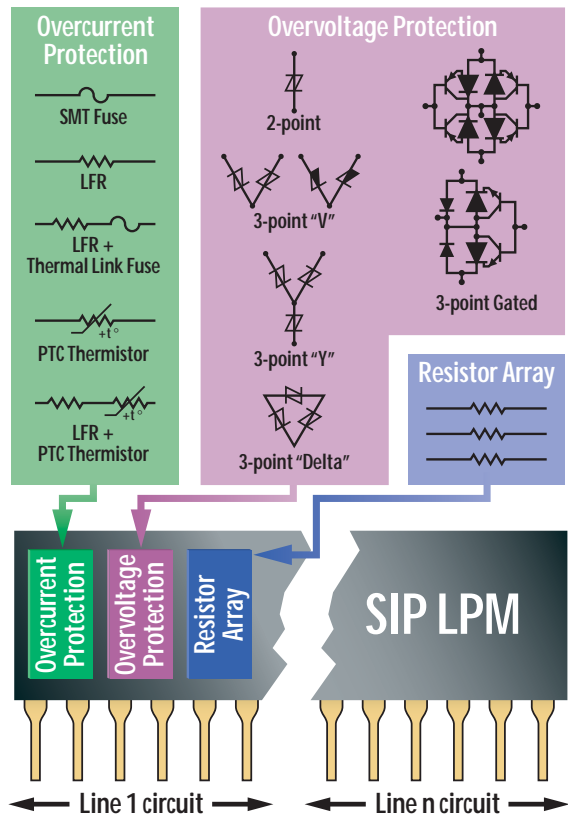

Figure 17. Multiple technologies may be integrated into a single, space-saving Line Protection Module

thereby allows smaller cross-section PTC thermistors to be used. The thermal coupling of an integrated module also ensures that the LFR heating further increases the rate of PTC thermistor temperature rise during AC faults causing faster low current tripping. The series LFR resistance will reduce the impulse current increase of ceramic thermistors and reduce the relative trip resistance change of polymer types.

It is worth noting that 10 mm SMT microfuses are now available (e.g. Bourns Telefuse™) with 600 V ratings to meet GR-1089-CORE, and UL 60950 safety requirements, and, dependent on application, these may be fitted in either one or both signal lines. LFR technology can also be used to fabricate precision high voltage resistors on the same substrate for non-protection use, such as power ring feed resistors and bridges for off-hook detection, giving further cost and PCB space savings.

As seen in “Modes of overvoltage protection”, it is important to match the protection topology (typically thyristor based) to the equipment being protected, with simple single-mode, 2-point protection being suitable for Tip to Ring protection applications such as modem coupling capacitor protection. The two-mode bidirectional 3-point “V” is a common configuration, protecting components connected between Tip or Ring and Ground, while SLICs powered from negative supplies need only a unidirectional 3-point “V”. Three-mode “Y” or “Delta” 3-point protection is used where protection is needed both to ground and inter-wire.

Figure 18 illustrates an LCAS protection module, with ±125 V Tip protection, and ±219 V Ring protection in a 3-point “V” configuration, complete with LFRs and thermal link fuses.

As with discrete device solutions, gated thyristor protectors can be used to significantly reduce voltage stress for sensitive SLICs and current stress on downstream protection circuits. Once again the thermal coupling between a PTC thermistor and a heating element is beneficial. Heat from the thyristor speeds up thermistor tripping under power induction

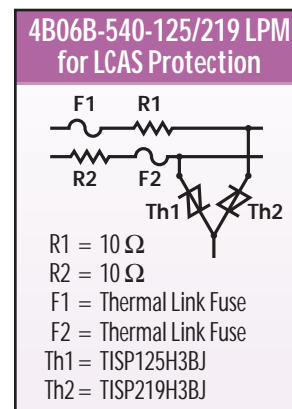



Figure 18. An example of an LPM integrated LCAS protection module

conditions. Further, the thyristor long-term temperature rise is constrained to the trip temperature of the thermistor, thereby limiting the maximum protection voltage under low AC conditions.

Each module can provide multiple circuits, protecting 2, 4 or 6 lines with a single module. The use of UL Recognized components greatly eases both consistency of performance and UL recognition of the module. System-level design is simplified, because individual component variations are handled during the module design, enabling the module to be considered as a network specified to withstand defined stress levels at the input, while passing known stresses to downstream components.

Bourns Products



Bourns offers a variety of Line Protection Module (LPM) products, including custom options.





GDT Gas Discharge Tubes Selection Guide

GDT Operation

Bourns® GDTs prevent damage from transient disturbances by acting as a “crowbar”, i.e. a short circuit. When an electrical surge exceeds the GDT’s defined sparkover voltage level (surge breakdown voltage), the GDT becomes ionized, and conduction takes place within a fraction of a microsecond. When the surge passes and the system voltage returns to normal levels, the GDT returns to its high-impedance (off) state.

Bourns GDT Features

- Unmatched performance and reliability
- Various lead configurations
- Smallest size in the industry (Mini 2-Pole and MINI TRIGARD™)
- Very high surge handling capability
- Extremely low work function for long service life
- Low capacitance & insertion loss
- Highly symmetrical cross-ionization
- Non-radioactive materials
- Optional Switch-Grade Fail-Short
- “Crowbar” function to less than 10 V arc voltage
- Telcordia, RUS, ITU-T, IEC, IEEE and UL compliant
- Broadband network capable
- Through-hole, SMT and cassette mounting types available
- Surge Protector Test Set (Model 4010-01) available for GDTs and other technologies

	Model	DC Sparkover Voltage	No. of Electrodes	Dimensions (Dia. x Length)	Max. Single Surge Rating (8/20 µs)	Max. Surge Rating (8/20 µs)	Max. AC Rating	Switch-Grade Fail-Short Operation	Capacitance	Min. Surge Life Rating (10/1000 µs waveshape)
	2026-07	75 V	3	8 mm x 11.2 mm	40 kA	10 x 20 kA	10 x 20 A rms, 1 s	Yes	<2 pF	400 x 1000 A
	2026-09	90 V								
	2026-15	150 V								
	2026-20	200 V								
	2026-23	230 V								
	2026-25	250 V								
	2026-30	300 V								
	2026-35	350 V								
	2026-40	400 V								
	2026-42	420 V								
	2026-47	470 V								
	2026-60	600 V								
	2036-07	75 V	3	5 mm x 7.5 mm	20 kA	10 x 10 kA	10 x 10 A rms, 1 s	Yes	<2 pF	500 x 200 A
	2036-09	90 V								
	2036-15	150 V								
	2036-20	200 V								
	2036-23	230 V								
	2036-25	250 V								
	2036-30	300 V								
	2036-35	350 V								
	2036-40	400 V								
	2036-42	420 V								
	2036-47	470 V								
	2036-60	600 V								

The rated discharge current for 3-Electrode GDTs is the total current equally divided between each line to ground.

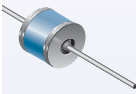
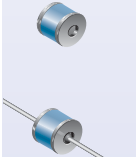
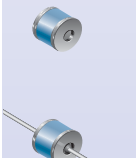
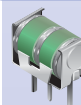
Model	DC Sparkover Voltage	No. of Electrodes	Dimensions (Dia. x Length)	Max. Single Surge Rating (8/20 μ s)	Max. Surge Rating	Max. AC Rating	Switch-Grade Fail-Short Operation	Capacitance	Min. Surge Life Rating (10/1000 μ s)
 2027-09 2027-15 2027-20 2027-23 2027-25 2027-30 2027-35 2027-40 2027-42 2027-47 2027-60	90 V	2	8 mm x 6 mm	25 kA	10 x 10 kA	10 x 10 A rms, 1 s	N/A	<1 pF	500 x 500 A
	150 V								
	200 V								
	230 V								
	250 V								
	300 V								
	350 V								
	400 V								
	420 V								
	470 V								
600 V									
 2037-09 2037-15 2037-20 2037-23 2037-25 2037-30 2037-35 2037-40 2037-42 2037-47 2037-60	90 V	2	5 mm x 5 mm	10 kA	10 x 5 kA	10 x 5 A rms, 1 s	N/A	<1 pF	500 x 100 A
	150 V								
	200 V								
	230 V								
	250 V								
	300 V								
	350 V								
	400 V								
	420 V								
	470 V								
600 V									
 2035-09 2035-15 2035-20 2035-23 2035-25 2035-30 2035-35 2035-40 2035-42 2035-47 2035-60	90 V	2	5 mm x 4 mm	10 kA	10 x 5 kA	10 x 5 A rms, 1 s	N/A	<1 pF	500 x 100 A
	150 V								
	200 V								
	230 V								
	250 V								
	300 V								
	350 V								
	400 V								
	420 V								
	470 V								
600 V									
 2026-23-xx-MSP 2026-33-xx-MSP	230 V 330 V	3	8 mm x 14 mm	40 kA	10 x 20 kA	20 x 10 A rms, 1 s	Standard	<20 pF	1000 x 1000 A

MSP® = Multi-Stage Protection



The rated discharge current for 3-Electrode GDTs is the total current equally divided between each line to ground.

Multifuse®
Resettable Fuses

Selection Guide

Bourns' range of Multifuse® Polymer PTCs have been designed to limit overcurrents in telecommunication equipment as well as many other types of equipment. Adequate overcurrent protection is needed to allow equipment to comply with international standards. Overcurrents can be caused

by AC power or lightning flash disturbances that are induced or conducted on to the telephone line. Our extensive range offers multiple voltage variants to suit specific application requirements. Our devices are available in surface mount, radial, disk and strap type packages.

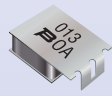
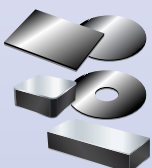
Product Series	Part Number	Vmax (V)	Ihold (A)	Imax (I)	Rmin (Ω)	Rmax (Ω)	R ₁ max (Ω)	Pd (W)	Telecom Standards
 MF-R/90	MF-R055/90	90	0.55	10.0	0.450	0.900	2.000	2.00	N/A
	MF-R055/90U	90	0.55	10.0	0.450	0.900	2.000	2.00	
	MF-R075/90	90	0.75	10.0	0.370	0.750	1.650	2.00	
 MF-R/250	MF-R008/250	250	0.08	3.0	14.000	20.000	33.000	1.00	ITU-T K.20/21/45 GR-1089 Intrabuilding
	MF-R011/250	250	0.11	3.0	5.000	9.000	16.000	1.00	
	MF-R012/250	250	0.12	3.0	4.000	8.000	16.000	1.00	
	MF-R012/250-A	250	0.12	3.0	7.000	9.000	16.000	1.00	
	MF-R012/250-C	250	0.12	3.0	5.500	7.500	16.000	1.00	
	MF-R012/250-F	250	0.12	3.0	6.000	10.500	16.000	1.00	
	MF-R012/250-1	250	0.12	3.0	6.000	9.000	16.000	1.00	
	MF-R012/250-2	250	0.12	3.0	8.000	10.500	16.000	1.00	
	MF-R012/250-80	250	0.12	3.0	4.000	8.000	16.000	1.00	
	MF-R014/250	250	0.14	3.0	3.000	6.000	14.000	1.00	
	MF-R014/250-A	250	0.14	3.0	3.000	5.500	12.000	1.00	
	MF-R014/250-B	250	0.14	3.0	4.500	6.000	14.000	1.00	
	MF-R018/250	250	0.18	10.0	0.800	2.000	4.000	1.00	
 MF-SM/250	MF-SM013/250	250	0.13	3.0	6.000	12.000	20.000	3.00	ITU-T K.20/21/45 GR-1089 Intrabuilding
	MF-SM013/250-A	250	0.13	3.0	6.500	9.000	20.000	3.00	
	MF-SM013/250-B	250	0.13	3.0	9.000	12.000	20.000	3.00	
	MF-SM013/250-C	250	0.13	3.0	7.000	10.000	20.000	3.00	
	MF-SM013/250-D	250	0.13	3.0	7.000	9.000	20.000	3.00	
	MF-SM013/250V	250	0.13	3.0	4.000	7.000	20.000	3.00	
 MF-D/250	MF-D008/250	250	0.08	3.0	14.000	20.000	33.000	1.00	ITU-T K.20/21/45 GR-1089 Intrabuilding
	MF-D011/250	250	0.11	3.0	5.000	9.000	16.000	1.00	
	MF-D012/250	250	0.12	3.0	4.000	8.000	16.000	1.00	
	MF-D013/250	250	0.13	3.0	6.000	12.000	20.000	1.00	
	MF-D014/250	250	0.14	3.0	3.000	6.000	14.000	1.00	
	MF-D018/250	250	0.18	10.0	0.800	2.000	4.000	1.00	

Device Options:

- Coated or Uncoated
- Un-Tripped or Pre-Tripped
- Narrow resistance bands
- Custom specified resistance bands
- Resistance sort to 0.5 ohm bins
- Disks with and without solder coating

Packaging Options:

- Bulk packed
- Tape and reel
- Custom lead lengths



Thyristor Surge Protectors

Selection Guide

Our world-class TISP® Thyristor Surge Protectors are designed to limit overvoltages on telephone lines. Adequate overvoltage protection is needed to allow equipment to comply with international standards. Overvoltages can be caused by AC power or lightning flash disturbances that are induced or conducted on

to the telephone line. Our extensive range offers multiple voltage variants to suit specific application requirements. Our devices are available in surface-mount or through-hole packages and are guaranteed to withstand international lightning surges.

TISP1xxx Series - Dual Unidirectional Overvoltage Protectors

Device	Delivery Options	Standoff Voltage V_{DRM} V	Protection Voltage $V_{(BO)}$ V	IppSM Ratings for Lightning Surge Standards			
				GR-1089-CORE 2/10 μ s A	10/1000 μ s A	ANSI C62.41 8/20 μ s A	ITU-T K.20/45/21 5/310 μ s A
TISP1072F3	DR, P, SL	58	72	80	35	70	50
TISP1082F3	DR, P, SL	66	82	80	35	70	50

TISP3xxx Series - Dual Bidirectional Overvoltage Protectors

Device	Delivery Options	Standoff Voltage V_{DRM} V	Protection Voltage $V_{(BO)}$ V	IppSM Ratings for Lightning Surge Standards			
				GR-1089-CORE 2/10 μ s A	10/1000 μ s A	ANSI C62.41 8/20 μ s A	ITU-T K.20/45/21 5/310 μ s A
TISPL758LF3	DR	105, 180	130, 220	175	35	120	50
TISP3072F3	DR, P, SL	58	72	80	35	70	50
TISP3082F3	DR, P, SL	66	82	80	35	70	50
TISP3125F3	DR, P, SL	100	125	175	35	120	50
TISP3150F3	DR, P, SL	120	150	175	35	120	50
TISP3180F3	DR, P, SL	145	180	175	35	120	50
TISP3240F3	DR, P, SL	180	240	175	35	120	50
TISP3260F3	DR, P, SL	200	260	175	35	120	50
TISP3290F3	DR, P, SL	220	290	175	35	120	50
TISP3320F3	DR, P, SL	240	320	175	35	120	50
TISP3380F3	DR, P, SL	270	380	175	35	120	50
TISP3600F3	SL	420	600	190	45	175	70
TISP3700F3	SL	500	700	190	45	175	70
TISP3070H3	SL	58	70	500	100	300	200
TISP3080H3	SL	65	80	500	100	300	200
TISP3095H3	SL	75	95	500	100	300	200
TISP3115H3	SL	90	115	500	100	300	200
TISP3125H3	SL	100	125	500	100	300	200
TISP3135H3	SL	110	135	500	100	300	200
TISP3145H3	SL	120	145	500	100	300	200
TISP3180H3	SL	145	180	500	100	300	200
TISP3210H3	SL	160	210	500	100	300	200
TISP3250H3	SL	190	250	500	100	300	200
TISP3290H3	SL	220	390	500	100	300	200
TISP3350H3	SL	275	350	500	100	300	200

TISP3xxx Series - Dual Bidirectional Overvoltage Protectors (Continued)

Device	Delivery Options	Standoff Voltage V _{DRM} V	Protection Voltage V _(BO) V	IppSM Ratings for Lightning Surge Standards			
				GR-1089-CORE 2/10 μs A	GR-1089-CORE 10/1000 μs A	ANSI C62.41 8/20 μs A	ITU-T K.20/45/21 5/310 μs A
TISP3070T3	BJR	58	70	250	80	250	120
TISP3080T3	BJR	65	80	250	80	250	120
TISP3095T3	BJR	75	95	250	80	250	120
TISP3115T3	BJR	90	115	250	80	250	120
TISP3125T3	BJR	100	125	250	80	250	120
TISP3145T3	BJR	120	145	250	80	250	120
TISP3165T3	BJR	135	165	250	80	250	120
TISP3180T3	BJR	145	180	250	80	250	120
TISP3200T3	BJR	155	200	250	80	250	120
TISP3219T3	BJR	180	219	250	80	250	120
TISP3250T3	BJR	190	250	250	80	250	120
TISP3290T3	BJR	220	290	250	80	250	120
TISP3350T3	BJR	275	350	250	80	250	120
TISP3395T3	BJR	320	395	250	80	250	120

TISP4xxxF3 Series (35 A 10/1000 μs, 150 mA I_H) - Single Bidirectional Overvoltage Protectors

Device	Delivery Options	Standoff Voltage V _{DRM} V	Protection Voltage V _(BO) V	IppSM Ratings for Lightning Surge Standards			
				GR-1089-CORE 2/10 μs A	GR-1089-CORE 10/1000 μs A	TIA/EIA-IS-968 (FCC PART 68) 10/560 μs A	ITU-T K.20/45/21 5/310 μs A
TISP4072F3	LM, LMR, LMFR	58	72	80	35	60	50
TISP4082F3	LM, LMR, LMFR	66	82	80	35	60	50
TISP4125F3	LM, LMR, LMFR	100	125	175	35	60	50
TISP4150F3	LM, LMR, LMFR	120	150	175	35	60	50
TISP4180F3	LM, LMR, LMFR	145	180	175	35	60	50
TISP4240F3	LM, LMR, LMFR	180	240	175	35	60	50
TISP4260F3	LM, LMR, LMFR	200	260	175	35	60	50
TISP4290F3	LM, LMR, LMFR	220	290	175	35	60	50
TISP4320F3	LM, LMR, LMFR	240	320	175	35	60	50
TISP4380F3	LM, LMR, LMFR	270	380	175	35	60	50
TISP4600F3	LM, LMR, LMFR	420	600	190	45	110	70
TISP4700F3	LM, LMR, LMFR	500	700	190	45	110	70

TISP4xxxLx Series (30 A 10/1000 μs, 50 & 150 mA I_H) - Single Bidirectional Overvoltage Protectors

Device	Delivery Options	Standoff Voltage V _{DRM} V	Protection Voltage V _(BO) V	Holding Current I _H mA	IppSM Ratings for Lightning Surge Standards			
					GR-1089-CORE 2/10 μs A	GR-1089-CORE 10/1000 μs A	TIA/EIA-IS-968 (FCC PART 68) 10/560 μs A	ITU-T K.20/45/21 5/310 μs A
TISP4015L1	AJR, BJR	8	15	50	150	30	35	45
TISP4030L1	AJR, BJR	15	30	50	150	30	35	45
TISP4040L1	AJR, BJR	25	40	50	150	30	35	45
TISP4070L3	AJR	58	70	150	125	30	40	50
TISP4080L3	AJR	65	80	150	125	30	40	50
TISP4090L3	AJR	70	90	150	125	30	40	50
TISP4125L3	AJR	100	125	150	125	30	40	50
TISP4145L3	AJR	120	145	150	125	30	40	50
TISP4165L3	AJR	135	165	150	125	30	40	50
TISP4180L3	AJR	145	180	150	125	30	40	50
TISP4220L3	AJR	160	220	150	125	30	40	50
TISP4240L3	AJR	180	240	150	125	30	40	50
TISP4260L3	AJR	200	260	150	125	30	40	50
TISP4290L3	AJR	230	290	150	125	30	40	50

TISP4xxxLx Series (30 A 10/1000 μ s, 50 & 150 mA I_H) - Single Bidirectional Overvoltage Protectors (Continued)

Device	Delivery Options	Standoff Voltage V _{DRM} V	Protection Voltage V _(BO) V	Holding Current I _H mA	I _{ppSM} Ratings for Lightning Surge Standards			
					GR-1089-CORE		TIA/EIA-IS-968 (FCC PART 68)	ITU-T K.20/45/21
					2/10 μ s	10/1000 μ s	10/560 μ s	5/310 μ s
A	A	A	A					
TISP4320L3	AJR	240	320	150	125	30	40	50
TISP4350L3	AJR	275	350	150	125	30	40	50
TISP4360L3	AJR	290	360	150	125	30	40	50
TISP4395L3	AJR	320	395	150	125	30	40	50
TISP4070L3	BJR	58	70	150			30	40
TISP4350L3	BJR	275	350	150			30	40

TISP4xxxMx Series (50 A 10/1000 μ s, 150 mA I_H) - Single Bidirectional Overvoltage Protectors

Device	Delivery Options	Standoff Voltage V _{DRM} V	Protection Voltage V _(BO) V	I _{ppSM} Ratings for Lightning Surge Standards			
				GR-1089-CORE		TIA/EIA-IS-968 (FCC PART 68)	ITU-T K.20/45/21
				2/10 μ s	10/1000 μ s	10/560 μ s	5/310 μ s
A	A	A	A				
TISP4070M3	AJR, BJR, LM, LMR, LMFR	58	70	300	50	75	100
TISP4080M3	AJR, BJR, LM, LMR, LMFR	65	80	300	50	75	100
TISP4095M3	AJR, BJR, LM, LMR, LMFR	75	95	300	50	75	100
TISP4115M3	AJR, BJR, LM, LMR, LMFR	90	115	300	50	75	100
TISP4125M3	AJR, BJR, LM, LMR, LMFR	100	125	300	50	75	100
TISP4145M3	AJR, BJR, LM, LMR, LMFR	120	145	300	50	75	100
TISP4165M3	AJR, BJR, LM, LMR, LMFR	135	165	300	50	75	100
TISP4180M3	AJR, BJR, LM, LMR, LMFR	145	180	300	50	75	100
TISP4200M3	AJR, BJR	155	200	300	50	75	100
TISP4219M3	BJR	180	219	300	50	75	100
TISP4220M3	AJR, BJR, LM, LMR, LMFR	160	220	300	50	75	100
TISP4240M3	AJR, BJR, LM, LMR, LMFR	180	240	300	50	75	100
TISP4250M3	AJR, BJR, LM, LMR, LMFR	190	250	300	50	75	100
TISP4260M3	LM, LMR, LMFR	200	260	300	50	75	100
TISP4265M3	AJR, BJR, LM, LMR, LMFR	200	265	300	50	75	100
TISP4290M3	AJR, BJR, LM, LMR, LMFR	220	290	300	50	75	100
TISP4300M3	AJR, BJR, LM, LMR, LMFR	230	300	300	50	75	100
TISP4350M3	AJR, BJR, LM, LMR, LMFR	275	350	300	50	75	100
TISP4360M3	AJR, BJR, LM, LMR, LMFR	290	360	300	50	75	100
TISP4395M3	AJR, BJR, LM, LMR, LMFR	320	395	300	50	75	100
TISP4400M3	BJR, LM, LMR, LMFR	300	400	300	50	75	100
TISP4350MM	AJR, BJR	230	300	250	50	55	65
TISP4350MM	AJR, BJR	275	350	250	50	55	65
TISP4360MM	AJR, BJR	290	360	250	50	55	65

TISP4xxxTx Series (80 A 10/1000 μ s, 150 mA I_H) - Single Bidirectional Overvoltage Protectors

Device	Delivery Options	Standoff Voltage V _{DRM} V	Protection Voltage V _(BO) V	I _{ppSM} Ratings for Lightning Surge Standards			
				GR-1089-CORE		TIA/EIA-IS-968 (FCC PART 68)	ITU-T K.20/45/21
				2/10 μ s	10/1000 μ s	10/560 μ s	5/310 μ s
A	A	A	A				
TISP4290T3	BJR	220	290	250	80	100	120
TISP4350T3	BJR	275	350	250	80	100	120

TISP4xxxHx Series (100 A 10/1000 μ s, 150 & 225 mA I_H) - Single Bidirectional Overvoltage Protectors

Device	Delivery Options	Standoff Voltage V _{DRM} V	Protection Voltage V _(BO) V	Holding Current I _H mA	I _{ppSM} Ratings for Lightning Surge Standards			
					GR-1089-CORE		TIA/EIA-IS-968 (FCC PART 68)	ITU-T K.20/45/21
					2/10 μ s A	10/1000 μ s A	10/560 μ s A	5/310 μ s A
TISP4015H1	BJR	8	15	50	500	100	125	150
TISP4030H1	BJR	15	30	50	500	100	125	150
TISP4040H1	BJR	25	40	50	500	100	125	150
TISP4070H3	BJR, LM, LMR, LMFR	58	70	150	500	100	160	200
TISP4080H3	BJR, LM, LMR, LMFR	65	80	150	500	100	160	200
TISP4095H3	BJR, LM, LMR, LMFR	75	95	150	500	100	160	200
TISP4115H3	BJR, LM, LMR, LMFR	90	115	150	500	100	160	200
TISP4125H3	BJR, LM, LMR, LMFR	100	125	150	500	100	160	200
TISP4145H3	BJR, LM, LMR, LMFR	120	145	150	500	100	160	200
TISP4165H3	BJR, LM, LMR, LMFR	135	165	150	500	100	160	200
TISP4180H3	BJR, LM, LMR, LMFR	145	180	150	500	100	160	200
TISP4200H3	BJR, LM, LMR, LMFR	155	200	150	500	100	160	200
TISP4219H3	BJR	180	219	150	500	100	160	200
TISP4220H3	BJR	160	220	150	500	100	160	200
TISP4240H3	BJR, LM, LMR, LMFR	180	240	150	500	100	160	200
TISP4250H3	BJR, LM, LMR, LMFR	190	250	150	500	100	160	200
TISP4260H3	LM, LMR, LMFR	200	260	150	500	100	160	200
TISP4265H3	BJR	200	265	150	500	100	160	200
TISP4290H3	BJR, LM, LMR, LMFR	220	290	150	500	100	160	200
TISP4300H3	BJR, LM, LMR, LMFR	230	300	150	500	100	160	200
TISP4350H3	BJR, LM, LMR, LMFR	275	350	150	500	100	160	200
TISP4360H3	BJR	290	360	150	500	100	160	200
TISP4395H3	BJR, LM, LMR, LMFR	320	395	150	500	100	160	200
TISP4400H3	BJR, LM, LMR, LMFR	300	400	150	500	100	160	200
TISP4500H3	BJR	350	500	150	-	-	-	200
TISP4165H4	BJR	135	165	225	500	100	160	200
TISP4180H4	BJR	145	180	225	500	100	160	200
TISP4200H4	BJR	155	200	225	500	100	160	200
TISP4265H4	BJR	200	265	225	500	100	160	200
TISP4300H4	BJR	230	300	225	500	100	160	200
TISP4350H4	BJR	270	350	225	500	100	160	200

TISP4xxxJx Series (200 A 10/1000 μ s, 20 mA I_H) - Single Bidirectional Overvoltage Protectors

Device	Delivery Options	Standoff Voltage V _{DRM} V	Protection Voltage V _(BO) V	I _{ppSM} Ratings for Lightning Surge Standards			
				GR-1089-CORE		TIA/EIA-IS-968 (FCC PART 68)	ITU-T K.20/45/21
				2/10 μ s A	10/1000 μ s A	10/560 μ s A	5/310 μ s A
TISP4070J1	BJR	58	70	1000	200	300	350
TISP4080J1	BJR	65	80	1000	200	300	350
TISP4095J1	BJR	75	95	1000	200	300	350
TISP4115J1	BJR	90	115	1000	200	300	350
TISP4125J1	BJR	100	125	1000	200	300	350
TISP4145J1	BJR	120	145	1000	200	300	350
TISP4165J1	BJR	135	165	1000	200	300	350
TISP4180J1	BJR	145	180	1000	200	300	350
TISP4200J1	BJR	155	200	1000	200	300	350
TISP4219J1	BJR	180	219	1000	200	300	350
TISP4250J1	BJR	190	250	1000	200	300	350
TISP4290J1	BJR	220	290	1000	200	300	350
TISP4350J1	BJR	275	350	1000	200	300	350
TISP4395J1	BJR	320	395	1000	200	300	350

TISP5xxx Series - Single Unidirectional Overvoltage Protectors

Device	Delivery Options	Standoff Voltage V _{DRM} V	Protection Voltage V _(BO) V	I _{ppSM} Ratings for Lightning Surge Standards			
				GR-1089-CORE		TIA/EIA-IS-968 (FCC PART 68)	ITU-T K.20/45/21
				2/10 μs A	10/1000 μs A	10/160 μs A	5/310 μs A
TISP5070H3	BJR	-58	-70	500	100	250	200
TISP5080H3	BJR	-65	-80	500	100	250	200
TISP5095H3	BJR	-75	-95	500	100	160	200
TISP5110H3	BJR	-80	-110	500	100	250	200
TISP5115H3	BJR	-90	-115	500	100	250	200
TISP5150H3	BJR	-120	-150	500	100	250	200

TISP7xxx Series - Triple Element Bidirectional Overvoltage Protectors

Device	Delivery Options	Standoff Voltage V _{DRM} V	Protection Voltage V _(BO) V	I _{ppSM} Ratings for Lightning Surge Standards			
				GR-1089-CORE		ANSI C62.41	ITU-T K.20/45/21
				2/10 μs A	10/1000 μs A	8/20 μs A	5/310 μs A
TISP7015	DR	8	15		30	150	40
TISP7038	DR	28	38		30	150	40
TISP7072F3	DR, P, SL	58	72	85	45	80	70
TISP7082F3	DR, P, SL	66	82	85	45	80	70
TISP7125F3	DR, P, SL	100	125	190	45	175	70
TISP7150F3	DR, P, SL	120	150	190	45	175	70
TISP7180F3	DR, P, SL	145	180	190	45	175	70
TISP7240F3	DR, P, SL	180	240	190	45	175	70
TISP7260F3	DR, P, SL	200	260	190	45	175	70
TISP7290F3	DR, P, SL	220	290	190	45	175	70
TISP7320F3	DR, P, SL	240	320	190	45	175	70
TISP7350F3	DR, P, SL	275	350	190	45	175	70
TISP7380F3	DR, P, SL	270	380	190	45	175	70
TISP7070H3	SL	58	70	500	100	350	200
TISP7080H3	SL	65	80	500	100	350	200
TISP7095H3	SL	75	95	500	100	350	200
TISP7125H3	SL	100	125	500	100	350	200
TISP7135H3	SL	110	135	500	100	350	200
TISP7145H3	SL	120	145	500	100	350	200
TISP7165H3	SL	130	165	500	100	350	200
TISP7180H3	SL	145	180	500	100	350	200
TISP7200H3	SL	150	200	500	100	350	200
TISP7210H3	SL	160	210	500	100	350	200
TISP7220H3	SL	160	210	500	100	350	200
TISP7250H3	SL	200	250	500	100	350	200
TISP7290H3	SL	230	290	500	100	350	200
TISP7350H3	SL	275	350	500	100	350	200
TISP7400H3	SL	300	400	500	100	350	200

TISP6xxx Series - Dual Programmable Overvoltage Protectors

Device	Delivery Options	Standoff Voltage V _{DRM} V	Protection Voltage V _(BO) V	I _{ppSM} Ratings for Lightning Surge Standards			
				GR-1089-CORE 2/10 μs A	GR-1089-CORE 10/1000 μs A	ANSI C62.41 8/20 μs A	ITU-T K.20/45/21 5/310 μs A
TISP61060	DR, P	Programmable -5 to -85		50	30	-	
TISP61089	DR, P	Programmable 0 to -85		120	30	-	40
TISP61089S	DR	Programmable 0 to -85		120	30	-	40
TISP61089A	DR, P	Programmable 0 to -120		120	30	-	40
TISP61089AS	DR	Programmable 0 to -120		120	30	-	40
TISP61089B	DR	Programmable 0 to -170		120	30	-	40
TISP61511	DR	Programmable 0 to -85		170	30	90	40
TISP61512	P	Programmable 0 to -85		170	30	90	40
TISP61521	DR	Programmable 0 to -170		170	30	100	40
TISPPBL1	DR, P, SE	Programmable 0 to -90		100	30	-	40
TISPPBL2	DR, P	Programmable 0 to -90		100	30	-	40
TISPPBL2S	DR	Programmable 0 to -90		100	30	-	40
TISPPBL3	DR	Programmable 0 to -170		100	30	-	40

TISP6NTP2x Series - Dual Programmable Overvoltage Protectors

Device	Delivery Options	Standoff Voltage V _{DRM} V	Protection Voltage V _(BO) V	I _{ppSM} Ratings for Lightning Surge Standards			
				GR-1089-CORE 2/10 μs A	GR-1089-CORE 10/1000 μs A	ANSI C62.41 8/20 μs A	ITU-T K.20/45/21 5/310 μs A
TISP6NTP2A	DR	Programmable 0 to -90		85	20	60	25
TISP6NTP2B	DR	Programmable 0 to -120		70	20	60	25

TISP8250 - Programmable Unidirectional Overvoltage Protectors

Device	Delivery Options	Standoff Voltage V _{DRM} V	Protection Voltage V _(BO) V	I _{ppSM} Ratings for Lightning Surge Standards		
				GR-1089-CORE 2/10 μs A	GR-1089-CORE 10/1000 μs A	ITU-T K.20/45/21 5/310 μs A
TISP8250	DR	250	340	75	30	40

TISP820xM Series - Dual Unidirectional Reverse Blocking Programmable Overvoltage Protectors

Device	Delivery Options	Standoff Voltage V _{DRM} V	Protection Voltage V _(BO) V	Holding Current I _H mA	I _{ppSM} Ratings for Lightning Surge Standards		
					GR-1089-CORE 2/10 μs A	GR-1089-CORE 10/1000 μs A	ITU-T K.20/45/21 5/310 μs A
TISP8200M	DR	Programmable 0 to -90		-150	-45	-210	-70
TISP8201M	DR	Programmable 0 to +90		+20	+45	+210	+70

TISP83121 Series - Dual-Gate Unidirectional Overvoltage Protectors

Device	Delivery Options	Standoff Voltage V _{DRM} V	Protection Voltage V _(BO) V	I _{ppSM} Ratings for Lightning Surge Standards		
				GR-1089-CORE 10/1000 μs A	ANSI C62.41 8/20 μs A	ITU-T K.20/45/21 5/310 μs A
TISP83121	DR	Programmable 0 to ±100		150	500	150



Surge Line Protection Modules Selection Guide

Features

- Precision thick-film technology
- Withstands lightning and AC power cross
- Complies with Telcordia (Bellcore) GR-1089 requirements
- Complies with ITU-T K.20 requirements
- Surface mount solution
- Guaranteed to fail safely under fault conditions
- Optional one-shot thermal fuse
- Optional resettable PTC
- UL 497A recognized
- Non-flammable
- Standard offerings
- Custom designs
- Full qualification test capabilities
- Central Office, Remote and Customer Premise Equipment applications include:
 - Analog linecards
 - xDSL linecards
 - Pairgain
 - VoIP
 - PBX systems
 - External and intra-buildings
 - LCAS protection

Custom Designs

In addition to the various standard off-the-shelf versions available, Bourns offers extensive custom options. Examples include:

- Variety of packages, e.g. vertical and horizontal SMD
- Packaging options, e.g. trays, tape and reel, bulk
- Additional resistors, e.g. ringing power resistors
- Additional components, e.g. fuses, PTCs, overvoltage protection
- Resistors from 5.6 Ω
- Ratio matching: down to 0.3 %, or less with special limitations

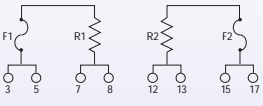
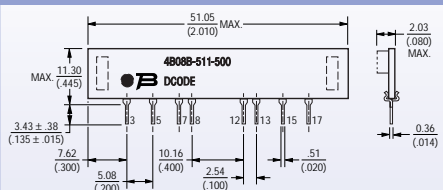
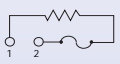
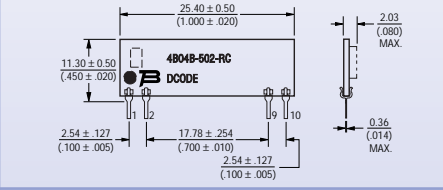
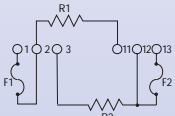
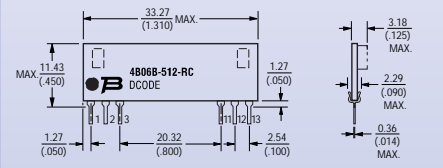



Model	Schematic	Dimensions	Description
4B08B-511-500			<ul style="list-style-type: none"> • 2x 50 Ω, 1% • 0.5 % matching • Thermal fuses
4B04B-502-RC	<p>Functional Schematic*</p>  <p>*User must short pins 9 & 10 on the circuit board.</p>		<ul style="list-style-type: none"> • 1x R Ω, 5 % • Values 5.6-100 Ω • Thermal fuse
4B06B-512-RC			<ul style="list-style-type: none"> • 2x R Ω, 5 % • Values 5.6-100 Ω • 0.5 % matching • Thermal fuses

Model	Schematic	Dimensions	Description
4A08P-505-RC			<ul style="list-style-type: none"> • 2x R Ω, 5 % • Values 5.6-100 Ω • 1 % matching
4A12P-516-500			<ul style="list-style-type: none"> • 4x 50 Ω, 1 % • 0.5 % matching • Thermal fuses
4B06B-514-500			<ul style="list-style-type: none"> • 2x 50 Ω, 1 % • 1.0 % matching • Resettable Multifuse® PPTC
4B07B-530-400			<ul style="list-style-type: none"> • 2x 40 Ω, 2 % • 0.5 % matching • Integrated overvoltage TISP®
4B06B-540-125/219			<ul style="list-style-type: none"> • 2x 10 Ω, 5 % • 2.0 % matching • Integrated overvoltage TISP®

Selection Guide

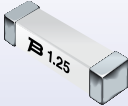
Features

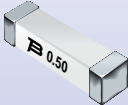
- Model 1250T is designed for use in telecommunications circuit applications requiring low current protection with high surge tolerance
- Ideal for protecting Central Office and Customer Premise Equipment, including POTS, T1/E1, ISDN and xDSL circuits
- Model B1250T allows overcurrent compliance with telecom specifications including Telcordia GR-1089, UL 60950, and ITU K.20 and K.21
- Model B0500T is a lower current version for use in applications where a faster opening time may be required

Model	Device Symbol	Ampere Rating A	Voltage Rating V	Peak Surge Current 10/1000 A
B1250T 		1.25	600	100
B0500T 		0.5	600	25

Worldwide Sales Offices

Country	Phone	Fax
Benelux:	+31-70-3004333	+31-70-3004345
China:	+86-21-64821250	+86-21-64821249
France:	+33-254-735151	+33-254-735156
Germany:	+49-69-80078212	+49-69-80078299
Hong Kong:	+852-2411 5599	+852-2412 3611
Ireland:	+44-1276-691087	+44-1276-691088
Italy:	+39-02-38900041	+39-02-38900042
Japan:	+81-49-269 3204	+81-49-269 3297
Singapore:	+65-63461933	+65-63461911
Switzerland:	+41-41-7685555	+41-41-7685510
Taiwan:	+886-2-25624117	+886-2-25624116
UK:	+44-1276-691087	+44-1276-691088
USA:	+1-909-781-5500	+1-909-781-5006
Non-Listed European Countries:	+41- 41-7685555	+41- 41-7685510

Technical Assistance

Region	Phone	Fax
Asia-Pacific:	+886-2-25624117	+886-2-25624116
Europe:	+41- 41-7685555	+41- 41-7685510
North America:	+1-909-781-5500	+1-909-781-5700

www.bourns.com
www.bournscircuitprotection.com

Bourns® products are available through an extensive network of manufacturer's representatives, agents and distributors. To obtain technical applications assistance, a quotation, or to place an order, contact a Bourns representative in your area.



"Telefuse" and "MINI TRIGARD" are trademarks of Bourns, Inc.
"TISP" is a trademark of Bourns, Ltd., and is Registered in U.S. Patent and Trademark Office.
"Multifuse and MSP" are registered trademarks of Bourns, Inc.
"Bourns" is a registered trademark of Bourns, Inc. in the U.S. and other countries.